

NETTUNO[®]

Marine Equipment

ITALIAN QUALITY BOAT COVERS

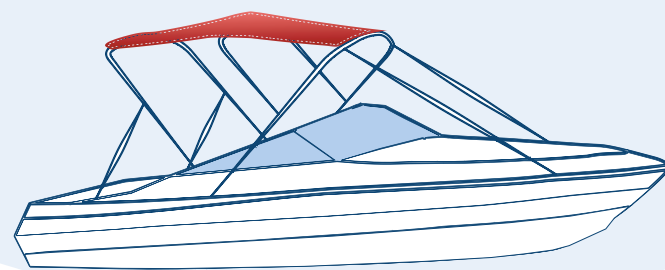

CATALOGO 2024

CATALOGUE 2024



Ⓢ **NETTUNO Marine Equipment**[®]
propone un'esclusiva collezione di
tendalini e coperture nautiche
che rendono unici e funzionali
gli esterni dell'imbarcazione.

Il brand italiano, fondato nel 1970, ha rinnovato il linguaggio della tecnica e della funzionalità a bordo. Sincronizzando sapienza artigianale e tecnologia industriale, Nettuno Marine Equipment è riuscita a progettare nuovi accessori capaci di rendere **l'arte della sartoria protagonista del mare.**

Ⓢ **NETTUNO Marine Equipment**[®]
offers an exclusive collection of
Bimini Tops and nautical covers
that make the exterior of the boat
unique and functional.

*The Italian brand, founded on 1970, has renewed the language of technology and functionality on board. By synchronizing craftsmanship and industrial technology, Nettuno Marine Equipment has succeeded in designing new accessories able to make **the art of tailoring the protagonist of the sea.***

NETTUNO[®]
Marine Equipment

Guida alla scelta del tendalino Bimini Top selection guide 8

01

Tendalini Bimini Tops 17

MAJESTIC 4 ARCHI • 4 ARCHES	18
EXCLUSIVE 4 ARCHI • 4 ARCHES	20
LOOK UP 4 ARCHI • 4 ARCHES	22
LOOK UP 3 ARCHI • 3 ARCHES	24
ROYAL XL 4 ARCHI • 4 ARCHES	26
ROYAL 4 ARCHI • 4 ARCHES	28
ROYAL 3 ARCHI • 3 ARCHES	30
CHIC 4 ARCHI • 4 ARCHES	32
CHIC 3 ARCHI • 3 ARCHES	34
SPORT PLUS 4 ARCHI • 4 ARCHES	36
SPORT PLUS 3 ARCHI • 3 ARCHES	38
SPORT 4 ARCHI • 4 ARCHES	40
SPORT 3 ARCHI • 3 ARCHES	42
ELEGANCE PLUS 4 ARCHI • 4 ARCHES	44
ELEGANCE PLUS 3 ARCHI • 3 ARCHES	46
ELEGANCE 3 ARCHI • 3 ARCHES	48
ELEGANCE 2 ARCHI • 2 ARCHES	50
PRESTIGE 3 ARCHI • 3 ARCHES	52
CAGNARO STECCATO	54
CAGNARO	56
FISHER	58
TENDALINO CON PALI IN CARBONIO	60
BIMINI TOP WITH CARBON POLES	60

02

Roll Bars 63

STRANGE XL 3 ARCHI • 3 ARCHES	64
STRANGE 3 ARCHI • 3 ARCHES	66
SUPERIOR	68
FRONT SUPERIOR	70
EXCELLENT	72
UNIVERSAL	74
JOLLY	76
ROLL BAR	78

03

T-Top 81

T-TOP	82
SPRAYHOOD	84
CHIUSURA COMPLETA	85
FULL CLOSURE	85

04

Coperture Covers 87

COPRICONSOLE • CONSOLE COVERS	88
COPRISEDILI • SEAT COVERS	89
COPRIMOTORI • ENGINE COVERS	90
COPRITIMONI • HELM COVERS	91
COPRIWINCH • WINCH COVERS	92
COPRI PASSO UOMO • HATCH COVERS	93
COPRIZATTERA • RESCUE BOAT COVER	93
COPRIRANDA • MAINSAIL COVERS	94
LAZY BAG • LAZY BAG	95
FRANGIVENTO • DODGERS	96
COPRIDRAGLIA • LIFELINES	97

05

Accessori per tendalini Accessories for Bimini Tops 99

BRACCI DI RINFORZO • STRUTS	100
TENDITORI • STRAPS	102
CAVETTI • TURNBUCKLES	103
ROTAIE • RAILS	103
BRACCIALE • BAND	103
ACCESSORI • ACCESSORIES	104
PALI IN CARBONIO • CARBON POLES	109

06

Accessori per Roll bars e T-Top Accessories for Roll bars and T-Top 111

07

Produzioni personalizzate Customizations 117

TELI PROLUNGA • EXTENSION CANVASES	118
CERNIERE • ZIPPERS	122
LED WATERPROOF	124
LUCE 360° • 360° LIGHT	125
RACING	126
STAMPA • PRINT	127

08

Telai Frames 129

PER TENDALINI • FOR BIMINI TOPS	130
PER SPRAYHOOD • FOR SPRAYHOOD	131

09

Tubi Tubes 133

10

Tessuti nautici Marine fabrics 137

11

Accessori tappezzeria Upholstery accessories 145



Azienda Our Company 157

INDEX

GUIDA ALLA SCELTA DEL TENDALINO

BIMINI TOPS SELECTION GUIDE

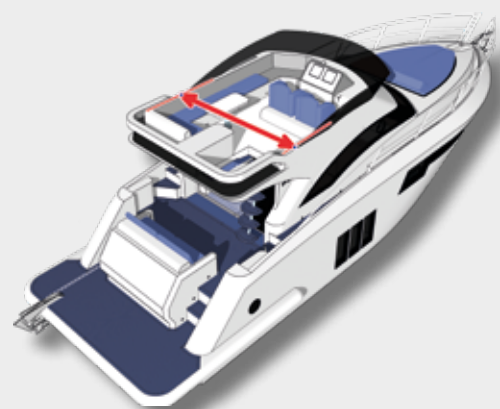

Larghezza

La prima misura da rilevare è la larghezza *centro murata* - centro murata o centro tubolare - *centro tubolare* per i gommoni.

Da questa possiamo valutare quale modello di tendalino è possibile installare.

Altezza

I tendalini **Nettuno Marine Equipment®** sono prodotti in altezza 95cm, 115cm e 140cm.

- Un tendalino in altezza **95cm** è indicato per installazioni su imbarcazioni con murata molto alta o per imbarcazioni veloci ove non è possibile restare in piedi.
- Un tendalino in altezza **115cm** è indicato per installazione su battagliola o su imbarcazioni con murata alta almeno 80cm.
- Per installazione su murata da 60cm circa è generalmente indicata un'altezza di **140cm**.

Numero di archi

Viene definito "arco" il tubo trasversale del tendalino che attraversa la barca nel senso della larghezza.

Un numero maggiore di archi si riflette in una maggiore robustezza del telaio e in una migliore tensione del tessuto di copertura.

Tessuto

Importante elemento da considerare è il tessuto con cui è realizzato il tendalino.

Su telai leggeri come quelli in alluminio $\varnothing 20/25$ mm o quelli in acciaio inox $\varnothing 20$ mm si utilizza **poliestere resinato**, mentre su telai più robusti come quelli in acciaio inox $\varnothing 22/25/30$ mm si utilizza **acrilico resinato**.

Telai

Il telaio è costituito da **tubi** e il diametro di questi influenza la robustezza complessiva del tendalino. I diametri disponibili sono $\varnothing 20/22/25/30/40$ mm.

I telai in **alluminio** o **acciaio inox** $\varnothing 20$ mm sono pratici e leggeri ed indicati per piccole imbarcazioni, mentre quelli con $\varnothing 22/25/30/40$ mm sono consigliati anche per barche con dimensioni maggiori.

I telai interamente in acciaio inox sono molto robusti e di grande impatto estetico.

Snodi

Altro elemento da considerare è il materiale degli snodi. Gli snodi in **nylon** sono applicati a tendalini leggeri con dimensioni ridotte, mentre gli snodi in **acciaio inox** sono generalmente applicati a strutture di dimensioni maggiori.

Attacchi

Elementi che ci permettono di installare il tendalino in diverse modalità. Sul piano, sulla battagliola, su rotaie scorrevoli e sui tubolari dei gommoni.

Si possono scegliere attacchi per le varie esigenze estetiche e funzionali, **per qualsiasi imbarcazione**, sia in nylon che in acciaio inox.

Width

The first measurement to take is the width between the right centre gunwale to the left centre one of the boat or, in case of an inflatable boat, the width between the right centre tubular to the centre left one.

From this size it can be evaluated which model of Bimini Top can be installed.

Height

Nettuno Marine Equipment® Bimini Tops are produced in height 95cm, 115cm and 140cm.

- A **95cm** high Bimini Top is suitable for installations on boats with very high gunwales or for fastboats where it is not possible to stand up.
- A **115cm** high Bimini Top is suitable for installation on guard rails or on boats with a minimum height of 80cm.
- For installation on gunwales of about 60cm, an height of **140cm** is generally recommended.

Number of arches

The transverse tube of the Bimini Top that crosses the boat in the direction of width is defined as an "arch".

A greater number of arches are reflected in a greater strength of the frame and in a better tension of the covering fabric.

Fabric

An important element to consider is fabric by which the Bimini Top is made of.

Resin-coated polyester is used on light frames such as those in aluminium $\varnothing 20/25$ mm or those in stainless steel $\varnothing 20$ mm whereas **resin-coated acrylic** is employed on stronger frames like stainless steel $\varnothing 22/25/30$ mm.

Frames

Frame is made of **tubes** and the diameter of these ones influences the overall strength of the Bimini Top.

The available diameters are **20/22/25/30/40mm**. The **aluminium** or **stainless steel** frames with diameter 20mm are handy and light and suitable for small boats, whereas those with diameter 22/25/30 or 40mm are recommended on larger boats. Whole stainless steel frames are very strong and of great aesthetic impact.

Jaw slides

Another element to consider is the material of the jaw slides. **Nylon** jaw slides are applied on light Bimini Tops with reduced dimensions, whereas **stainless steel** ones are applied to larger structures.

Deck hinges

Deck hinges are elements that allow installing the Bimini Top in different ways. On the floor, on the handrail, on sliding rails or on the tubulars of inflatable boats.

Deck hinges can be chosen according to the various aesthetic and functional requirements, **for any boat**, both in nylon or stainless steel.

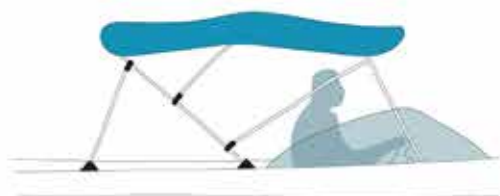
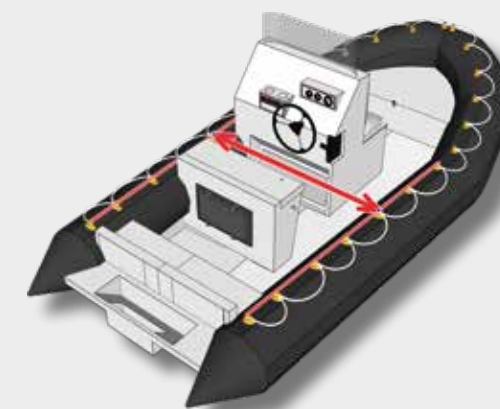

Altezza 95 cm
Height 95 cm

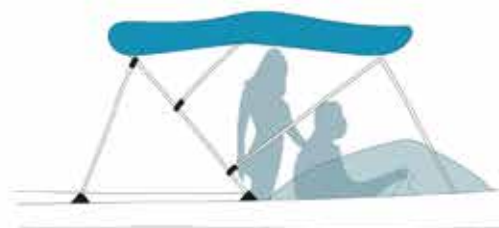

Altezza 115 cm
Height 115 cm

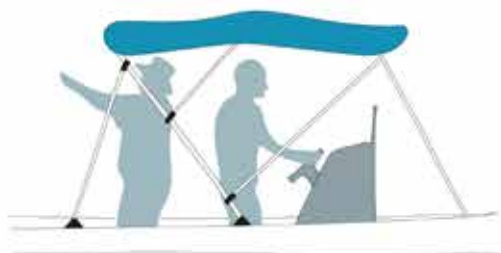

Altezza 140 cm
Height 140 cm

GUIDA ALLA SCELTA DEL TENDALINO

BIMINI TOPS SELECTION GUIDE

CARATTERISTICHE - FEATURES	MOD.	MAJESTIC	EXCLUSIVE	LOOK UP				
	TELAIO FRAME	Acciaio inox Ø40mm Stainless steel Ø40mm	Acciaio inox Ø30mm Stainless steel Ø30mm	Acciaio inox Ø25 Ø22mm Stainless steel Ø25 Ø22mm				
	SNODI HINGES	Acciaio inox Stainless steel	Acciaio inox Stainless steel	Acciaio inox Stainless steel				
	TESSUTO CANVAS	Acrilico resinato Resin-coated acrylic fabric	Acrilico resinato Resin-coated acrylic fabric	Acrilico resinato e rete Resin-coated acrylic fabric and mesh				
	N° ARCHI N° ARCHES	4 Archi 4 Arches	4 Archi 4 Arches	4 Archi 4 Arches	3 Archi 3 Arches			
	ALTEZZE CM HEIGHTS (INCHES)	140 (55")	140 (55")	115 (45")	140 (55")	95 (37")	115 (45")	140 (55")

LARGHEZZE CM - WIDTHS (INCHES)	110 (43")	→						
	130 (51")	→						
	150 (59")	→						
	170 (67")	→						
	185 (73")	→						
	200 (79")	→						
	215 (85")	→						
	230 (91")	→						
	245 (96")	→	TE24-E07L		TE01-E07L			
	260 (102")	→	TE24-E08L		TE01-E08L			
	275 (108")	→	TE24-E09L		TE01-E09L			
	290 (114")	→	TE24-E10L		TE01-E10L			
	305 (120")	→	TE24-E11L		TE01-E11L			
	320 (126")	→	TE24-E12L		TE01-E12L			
	335 (132")	→	TE24-E13L		TE01-E13L			
	350 (138")	→	TE24-E14L		TE01-E14L			
	365 (144")	→	TE24-E15L		TE01-E15L			
380 (150")	→	TE24-E16L		TE01-E16L				
395 (156")	→	TE24-E17L		TE01-E17L				

CARATTERISTICHE - FEATURES	MOD.	ROYAL XL	ROYAL				
	TELAIO FRAME	Acciaio inox Ø25mm Stainless steel Ø25mm	Acciaio inox Ø25 Ø22mm Stainless steel Ø25 Ø22mm				
	SNODI HINGES	Acciaio inox Stainless steel	Acciaio inox Stainless steel				
	TESSUTO CANVAS	Acrilico resinato Resin-coated acrylic fabric	Acrilico resinato Resin-coated acrylic fabric				
	N° ARCHI N° ARCHES	4 Archi 4 Arches	4 Archi 4 Arches	3 Archi 3 Arches			
	ALTEZZE CM HEIGHTS (INCHES)	140 (55")	115 (45")	140 (55")	95 (37")	115 (45")	140 (55")

LARGHEZZE CM - WIDTHS (INCHES)	110 (43")	→					
	130 (51")	→					
	150 (59")	→					
	170 (67")	→					
	185 (73")	→			TE05-A01A		
	200 (79")	→			TE05-A02A	TE05-B04D	TE05-E02F
	215 (85")	→	TE04-B05F	TE04-E03H	TE05-A03A	TE05-B05D	TE05-E03F
	230 (91")	→	TE04-B06F	TE04-E04H	TE05-A04A	TE05-B06D	TE05-E04F
	245 (96")	→	TE04-B07F	TE04-E05H	TE05-A05A	TE05-B07D	TE05-E05F
	260 (102")	→	TE04-B08F	TE04-E06H		TE05-B08D	TE05-E06F
	275 (108")	→	TE04-B09F	TE04-E07H		TE05-B09D	TE05-E07F
	290 (114")	→	TE04-B10F	TE04-E08H			
	305 (120")	→	TE04-B11F	TE04-E09H			
	320 (126")	→	TE04-B12F	TE04-E10H			
	335 (132")	→					
	350 (138")	→					
	365 (144")	→					
380 (150")	→						
395 (156")	→						

TENDALINI

I tendalini Nettuno Marine Equipment® sono concepiti per offrire la massima **protezione** e il massimo **comfort** a bordo di ogni imbarcazione.

Una collezione di **modelli standard** unita alla possibilità di **realizzazioni su misura**, fa di Nettuno Marine Equipment un'azienda unica nel suo genere. Un'ampia gamma di colori e misure, la possibilità di avere dimensioni differenti da quelle di serie, ma anche la realizzazione di tendalini completamente personalizzati, rende la proposta di Nettuno Marine Equipment® rara e ineguagliabile.

*Nettuno Marine Equipment® Bimini Tops are conceived to offer the maximum **protection and comfort**.*

*A collection of **standard models** together with the possibility of **customized** items, makes Nettuno Marine Equipment a unique company. Standard products available in a wide range of colours and sizes, the possibility of different dimensions from the standard ones, but also the manufacturing of fully customized Bimini Tops and covers, make Nettuno Marine Equipment® a rare and unparalleled company.*



BIMINI TOPS

01

MAJESTIC 4 ARCHI 4 ARCHES



1
Tubo
In acciaio inox lucido 316L Ø40mm.
Attacchi e viteria inox 316
Tube
Ø40 mm 316L polished stainless steel.
Joints and screws in 316 stainless steel



2
Cerniere sotto archi
Cerniera divisibile catena 8mm YKK
Zippers under the arches
Application of 8mm YKK divisible zipper



3
Telo
Tessuto 100% acrilico resinato,
bordo in tinta
Canvas
100% resin-coated acrylic fabric,
matching bordering tape

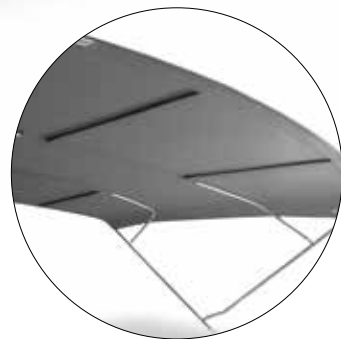

4
Fasce di sostegno
Fasce di sostegno per archi centrali
Support bands
Support bands for central arches



ACCESSORI DI SERIE • STANDARD ACCESSORIES

Applicazione della custodia sul tendalino
Storage bag application on the Bimini



Custodia
Sacca di custodia con cerniera
Storage bag
Zippered storage bag



Tenditori a nastro
N°1 coppia di tenditori a nastro
Straps
N°1 pair of straps

DIMENSIONI • DIMENSIONS

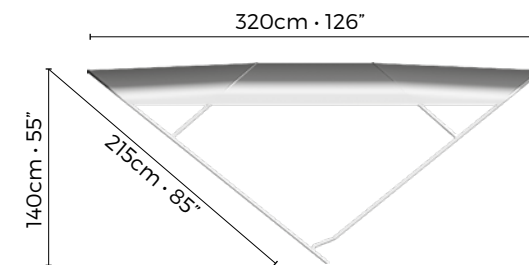

ALTEZZA 140cm • HEIGHT (55")

Codice Code	Larghezza cm Width (inches)
TE24-E07L	245 (96")
TE24-E08L	260 (102")
TE24-E09L	275 (108")
TE24-E10L	290 (114")
TE24-E11L	305 (120")
TE24-E12L	320 (126")
TE24-E13L	335 (132")
TE24-E14L	350 (138")
TE24-E15L	365 (144")
TE24-E16L	380 (150")
TE24-E17L	395 (156")



OPTIONAL

- ATTACCHI ACCIAIO INOX _____ Pag. 104
STAINLESS STEEL JOINTS
- LED WATERPROOF _____ Pag. 124
LED WATERPROOF
- RACING _____ Pag. 126
RACING
- CERNIERA SU BORDO _____ Pag. 122
ZIPPER ON EDGE
- TENDITORI, CAVETTI E ROTAIE _____ Pag. 102
STRAPS, TURNBUCKLES & RAILS
- BRACCI DI RINFORZO _____ Pag. 100
STRUTS
- TELI DI PROLUNGA _____ Pag. 118
EXTENSION CANVASES

INFO



Peso medio
Kg 35
Medium weight
Kg 35



Velocità consigliata
Max 35 Nodi
Recommended speed
Max 35 Knots



Nota Possibilità di realizzazioni fuori misure standard
Note Possibility of custom-made realizations

TENDALINI • BIMINI TOPS

EXCLUSIVE 4 ARCHI 4 ARCHES



1
Tubo
In acciaio inox lucido 316L Ø30mm.
Attacchi e viteria inox 316
Tube
Ø30 mm 316L polished stainless steel.
Joints and screws in 316 stainless steel

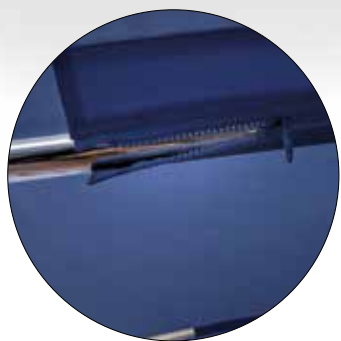

2
Cerniere sotto archi
Cerniera divisibile catena 8mm YKK
Zippers under the arches
Application of 8mm YKK divisible zipper

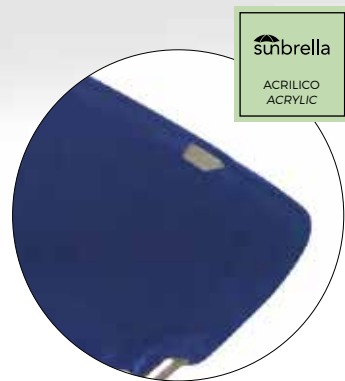

3
Telo
Tessuto 100% acrilico resinato,
bordo in tinta
Canvas
100% resin-coated acrylic fabric,
matching bordering tape

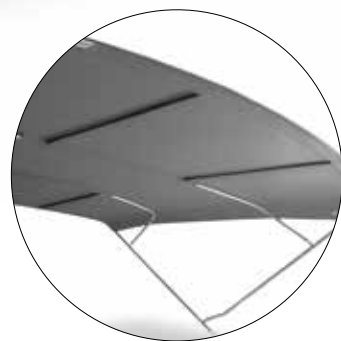

4
Fasce di sostegno
Fasce di sostegno per archi centrali
Support bands
Support bands for central arches

ACCESSORI DI SERIE • STANDARD ACCESSORIES

Applicazione della custodia sul tendalino
Storage bag application on the Bimini



Custodia
Sacca di custodia con cerniera
Storage bag
Zippered storage bag



Tenditori a nastro
N°1 coppia di tenditori a nastro
Straps
N°1 pair of straps

DIMENSIONI • DIMENSIONS

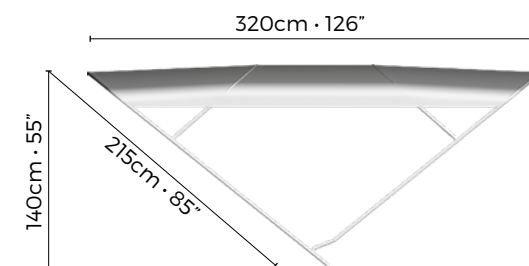

ALTEZZA 140cm • HEIGHT (55")

Codice Code	Larghezza cm Width (inches)
TE01-E07L	245 (96")
TE01-E08L	260 (102")
TE01-E09L	275 (108")
TE01-E10L	290 (114")
TE01-E11L	305 (120")
TE01-E12L	320 (126")
TE01-E13L	335 (132")
TE01-E14L	350 (138")
TE01-E15L	365 (144")
TE01-E16L	380 (150")
TE01-E17L	395 (156")

OPTIONAL

- ATTACCHI ACCIAIO INOX _____ Pag. 104
STAINLESS STEEL JOINTS
- LED WATERPROOF _____ Pag. 124
LED WATERPROOF
- LUCE 360° _____ Pag. 125
360° LIGHT
- RACING _____ Pag. 126
RACING
- CERNIERA SU BORDO _____ Pag. 122
ZIPPER ON EDGE
- TENDITORI, CAVETTI E ROTAIE _____ Pag. 102
STRAPS, TURNBUCKLES & RAILS
- BRACCI DI RINFORZO _____ Pag. 100
STRUTS
- TELI DI PROLUNGA _____ Pag. 118
EXTENSION CANVASES

INFO

-  **Peso medio**
Kg 25
Medium weight
Kg 25
-  **Velocità consigliata**
Max 30 Nodi
Recommended speed
Max 30 Knots



Nota Possibilità di realizzazioni fuori misure standard
Note Possibility of custom-made realizations



LOOK UP 4 ARCHI 4 ARCHES



1
Tubo
Acciaio inox lucido 316L ø 25mm.
Attacchi e viteria acciaio inox 316
Tube
ø 25mm polished stainless steel.
Joints and screws in 316 stainless steel



2
Telaio
Smontabile per il trasporto
Frame
Can be disassembled
for transport



3
Telo
Tessuto 100% acrilico resinato,
bordo in tinta
Canvas
100% resin-coated acrylic fabric,
matching bordering tape

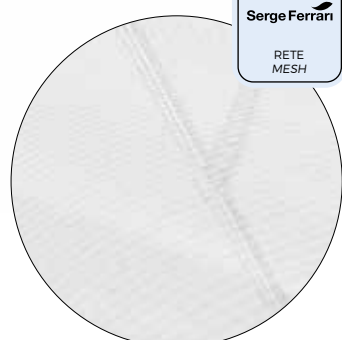

4
Rete
Rete microforata, resistente
ai raggi UV
Mesh
Micro-perforated mesh, UV resistant

ACCESSORI DI SERIE • STANDARD ACCESSORIES

Applicazione della custodia sul tendalino
Storage bag application on the Bimini



Custodia
Sacca di custodia con cerniera
Storage bag
Zippered storage bag



Tenditori a nastro
N°1 coppia di tenditori a nastro
Straps
N°1 pair of straps

DIMENSIONI • DIMENSIONS

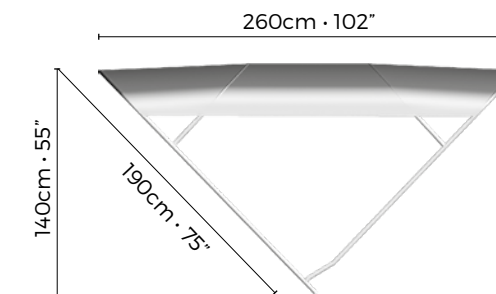
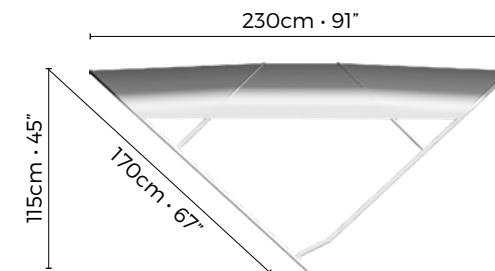

ALTEZZA 115cm • HEIGHT (45")

Codice Code	Larghezza cm Width (inches)
TE04-B05F	185 (73")
TE04-B06F	200 (79")
TE04-B07F	215 (85")
TE04-B08F	230 (91")
TE04-B09F	245 (96")
TE04-B10F	260 (102")
TE04-B11F	275 (108")
TE04-B12F	290 (114")

ALTEZZA 140cm • HEIGHT (55")

Codice Code	Larghezza cm Width (inches)
TE04-E03H	185 (73")
TE04-E04H	200 (79")
TE04-E05H	215 (85")
TE04-E06H	230 (91")
TE04-E07H	245 (96")
TE04-E08H	260 (102")
TE04-E09H	275 (108")
TE04-E10H	290 (114")

OPTIONAL

- ATTACCHI ACCIAIO INOX _____ Pag. 104
STAINLESS STEEL JOINTS
- LED WATERPROOF _____ Pag. 124
LED WATERPROOF
- LUCE 360° _____ Pag. 125
360° LIGHT
- RACING _____ Pag. 126
RACING
- CERNIERE _____ Pag. 122
ZIPPERS
- TENDITORI, CAVETTI E ROTAIE _____ Pag. 102
STRAPS, TURNBUCKLES & RAILS
- BRACCI DI RINFORZO _____ Pag. 100
STRUTS
- TELI DI PROLUNGA _____ Pag. 118
EXTENSION CANVASES

INFO



Peso medio
Kg 20
Medium weight
Kg 20



Velocità consigliata
Max 25 Nodi
Recommended speed
Max 25 Knots



Note
1 Possibilità di realizzazioni fuori misure standard
2 Indicare codice colore acrilico e rete
Note
1 Possibility of custom-made realizations
2 Indicate the acrylic and mesh color code

LOOK UP 3 ARCHI 3 ARCHES



1
Tubo
Acciaio inox lucido 316L Ø 22mm.
Attacchi e viteria in acciaio inox 316
Tube
Ø 22mm polished stainless steel.
Joints and screws in 316 stainless steel



2
Telaio
Smontabile per il trasporto
Frame
Can be disassembled
for transport



3
Telo
Tessuto 100% acrilico resinato,
bordo in tinta
Canvas
100% resin-coated acrylic fabric,
matching bordering tape

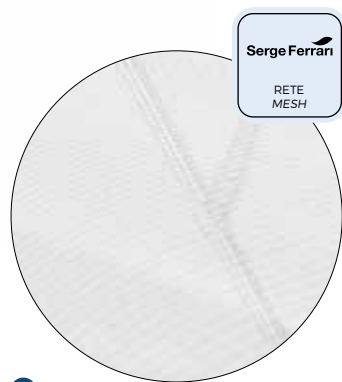

4
Rete
Rete microforata, resistente
ai raggi UV
Mesh
Micro-perforated mesh, UV resistant

ACCESSORI DI SERIE • STANDARD ACCESSORIES

Applicazione della custodia sul tendalino
Storage bag application on the Bimini



Custodia
Sacca di custodia con cerniera
Storage bag
Zippered storage bag



Tenditori a nastro
N°1 coppia di tenditori a nastro
Straps
N°1 pair of straps

DIMENSIONI • DIMENSIONS

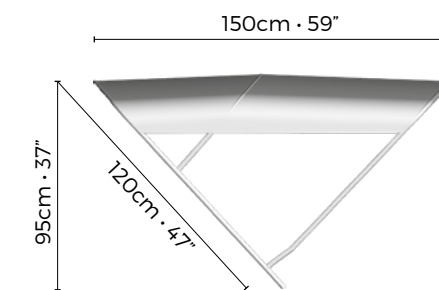

ALTEZZA 95cm • HEIGHT (37")

Codice Code	Larghezza cm Width (inches)
TE05-A01A	150 (59")
TE05-A02A	170 (67")
TE05-A03A	185 (73")
TE05-A04A	200 (79")
TE05-A05A	215 (85")

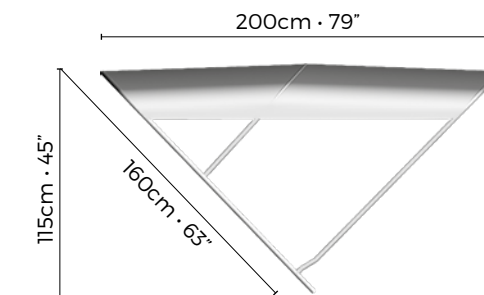

ALTEZZA 115cm • HEIGHT (45")

Codice Code	Larghezza cm Width (inches)
TE05-B04D	170 (67")
TE05-B05D	185 (73")
TE05-B06D	200 (79")
TE05-B07D	215 (85")
TE05-B08D	230 (91")
TE05-B09D	245 (96")

OPTIONAL

- ATTACCHI ACCIAIO INOX _____ Pag. 104
STAINLESS STEEL JOINTS
- LED WATERPROOF _____ Pag. 124
LED WATERPROOF
- LUCE 360° _____ Pag. 125
360° LIGHT
- RACING _____ Pag. 126
RACING
- CERNIERE _____ Pag. 122
ZIPPERS
- TENDITORI, CAVETTI E ROTAIE _____ Pag. 102
STRAPS, TURNBUCKLES & RAILS
- BRACCI DI RINFORZO _____ Pag. 100
STRUTS
- TELI DI PROLUNGA _____ Pag. 118
EXTENSION CANVASES

INFO



Peso medio
Kg 15
Medium weight
Kg 15



Velocità consigliata
Max 25 Nodi
Recommended speed
Max 25 Knots

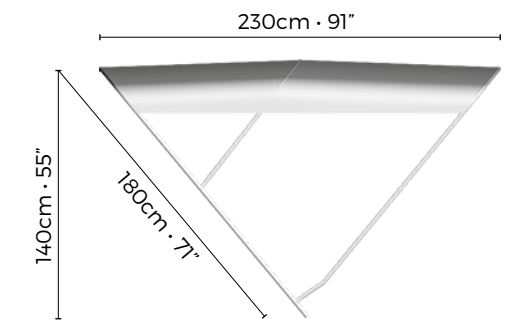

ALTEZZA 140cm • HEIGHT (55")

Codice Code	Larghezza cm Width (inches)
TE05-E02F	170 (67")
TE05-E03F	185 (73")
TE05-E04F	200 (79")
TE05-E05F	215 (85")
TE05-E06F	230 (91")
TE05-E07F	245 (96")

Note 1 Possibilità di realizzazioni fuori misure standard **2** Indicare codice colore acrilico e rete
Note 1 Possibility of custom-made realizations **2** Indicate the acrylic and mesh color code

ROYAL XL 4 ARCHI 4 ARCHES



1
Tubo
Acciaio inox lucido 316L Ø 25mm.
Attacchi e viteria in acciaio inox 316
Tube
Ø 25mm polished stainless steel.
Joints and screws in 316 stainless steel



2
Telaio
Smontabile per il trasporto
Frame
Can be disassembled
for transport



3
Telo
Tessuto 100% acrilico resinato,
bordo in tinta
Canvas
100% resin-coated acrylic fabric,
matching bordering tape

ACCESSORI DI SERIE • STANDARD ACCESSORIES

Applicazione della custodia sul tendalino
Storage bag application on the Bimini



Custodia
Sacca di custodia con cerniera
Storage bag
Zippered storage bag



Tenditori a nastro
N°1 coppia di tenditori a nastro
Straps
N°1 pair of straps

DIMENSIONI • DIMENSIONS

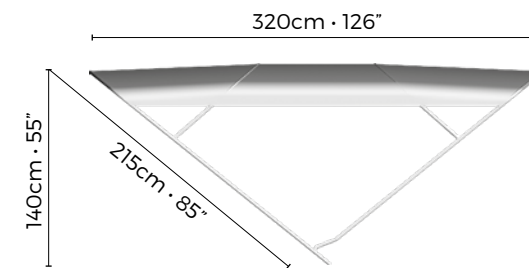

ALTEZZA 140cm • HEIGHT (55")

Codice Code	Larghezza cm Width (inches)
TE18-E03L	185 (73")
TE18-E04L	200 (79")
TE18-E05L	215 (85")
TE18-E06L	230 (91")
TE18-E07L	245 (96")
TE18-E08L	260 (102")
TE18-E09L	275 (108")
TE18-E10L	290 (114")

Note Possibilità di realizzazioni fuori misura standard
Note Possibility of custom-made realizations

OPTIONAL

- ATTACCHI ACCIAIO INOX _____ Pag. 104
STAINLESS STEEL JOINTS
- LED WATERPROOF _____ Pag. 124
LED WATERPROOF
- LUCE 360° _____ Pag. 125
360° LIGHT
- RACING _____ Pag. 126
RACING
- CERNIERE _____ Pag. 122
ZIPPERS
- TENDITORI, CAVETTI E ROTAIE _____ Pag. 102
STRAPS, TURNBUCKLES & RAILS
- BRACCI DI RINFORZO _____ Pag. 100
STRUTS
- TELI DI PROLUNGA _____ Pag. 118
EXTENSION CANVASES

INFO

KG **Peso medio**
Kg 20
Medium weight
Kg 20

Velocità consigliata
Max 25 Nodi
Recommended speed
Max 25 Knots



ROYAL 4 ARCHI 4 ARCHES



1
Tubo
Acciaio inox lucido 316L ø 25mm.
Attacchi e viteria in acciaio inox 316
Tube
ø 25mm Polished stainless steel.
Joints and screws in 316 stainless steel



2
Telaio
Smontabile per il trasporto
Frame
Can be disassembled
for transport

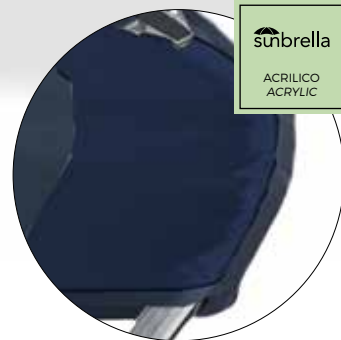

3
Telo
Tessuto 100% acrilico resinato,
bordo in tinta
Canvas
100% resin-coated acrylic fabric,
matching bordering tape



ACCESSORI DI SERIE • STANDARD ACCESSORIES

Applicazione della custodia sul tendalino
Storage bag application on the Bimini



Custodia
Sacca di custodia con cerniera
Storage bag
Zippered storage bag



Tenditori a nastro
N°1 coppia di tenditori a nastro
Straps
N°1 pair of straps

DIMENSIONI • DIMENSIONS

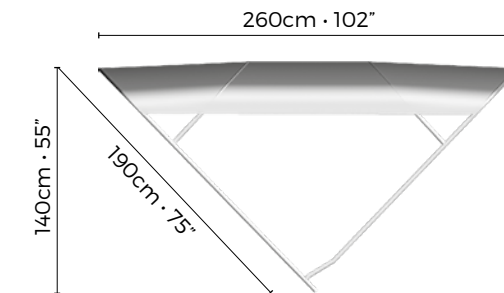
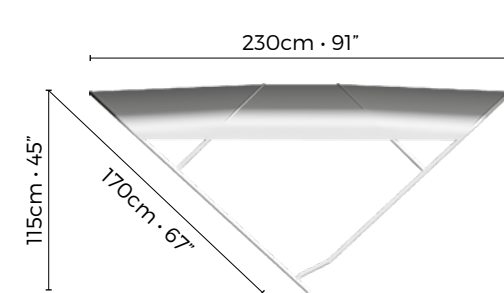

ALTEZZA 115cm • HEIGHT (45")	
Codice Code	Larghezza cm Width (inches)
TE06-B05F	185 (73")
TE06-B06F	200 (79")
TE06-B07F	215 (85")
TE06-B08F	230 (91")
TE06-B09F	245 (96")
TE06-B10F	260 (102")
TE06-B11F	275 (108")
TE06-B12F	290 (114")

ALTEZZA 140cm • HEIGHT (55")	
Codice Code	Larghezza cm Width (inches)
TE06-E03H	185 (73")
TE06-E04H	200 (79")
TE06-E05H	215 (85")
TE06-E06H	230 (91")
TE06-E07H	245 (96")
TE06-E08H	260 (102")
TE06-E09H	275 (108")
TE06-E10H	290 (114")

Note Possibilità di realizzazioni fuori misura standard • **Note** Possibility of custom-made realizations

OPTIONAL

- ATTACCHI ACCIAIO INOX _____ Pag. 104
STAINLESS STEEL JOINTS
- LED WATERPROOF _____ Pag. 124
LED WATERPROOF
- LUCE 360° _____ Pag. 125
360° LIGHT
- RACING _____ Pag. 126
RACING
- CERNIERE _____ Pag. 122
ZIPPERS
- TENDITORI, CAVETTI E ROTAIE _____ Pag. 102
STRAPS, TURNBUCKLES & RAILS
- BRACCI DI RINFORZO _____ Pag. 100
STRUTS
- TELI DI PROLUNGA _____ Pag. 118
EXTENSION CANVASES

INFO



Peso medio
Kg 20
Medium weight
Kg 20



Velocità consigliata
Max 25 Nodi
Recommended speed
Max 25 Knots



ROYAL 3 ARCHI 3 ARCHES



1
Tubo
Acciaio inox lucido 316L ø 22mm.
Attacchi e viteria in acciaio inox 316
Tube
ø 22mm polished stainless steel.
Joints and screws in 316 stainless steel



2
Telaio
Smontabile per il trasporto
Frame
Can be disassembled
for transport

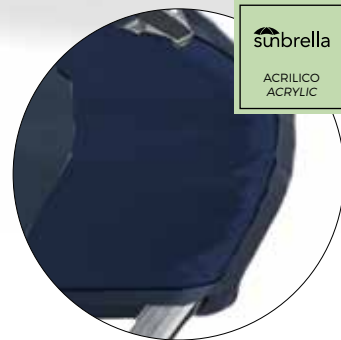

3
Telo
Tessuto 100% acrilico resinato,
bordo in tinta
Canvas
100% resin-coated acrylic fabric,
matching bordering tape

ACCESSORI DI SERIE • STANDARD ACCESSORIES

Applicazione della custodia sul tendalino
Storage bag application on the Bimini



Custodia
Sacca di custodia con cerniera
Storage bag
Zippered storage bag



Tenditori a nastro
N°1 coppia di tenditori a nastro
Straps
N°1 pair of straps

DIMENSIONI • DIMENSIONS

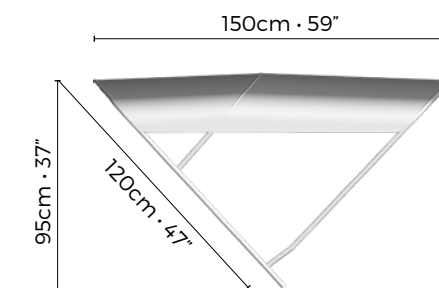

ALTEZZA 95cm • HEIGHT (37")

Codice Code	Larghezza cm Width (inches)
TE07-A01A	150 (59")
TE07-A02A	170 (67")
TE07-A03A	185 (73")
TE07-A04A	200 (79")
TE07-A05A	215 (85")

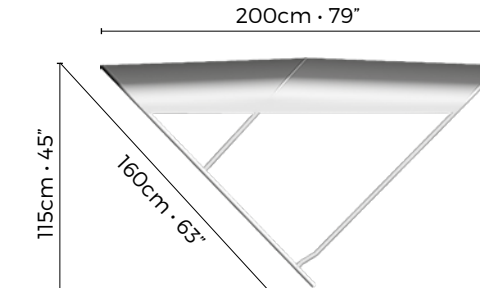

ALTEZZA 115cm • HEIGHT (45")

Codice Code	Larghezza cm Width (inches)
TE07-B04D	170 (67")
TE07-B05D	185 (73")
TE07-B06D	200 (79")
TE07-B07D	215 (85")
TE07-B08D	230 (91")
TE07-B09D	245 (96")

OPTIONAL

- ATTACCHI ACCIAIO INOX _____ Pag. 104
STAINLESS STEEL JOINTS
- LED WATERPROOF _____ Pag. 124
LED WATERPROOF
- LUCE 360° _____ Pag. 125
360° LIGHT
- RACING _____ Pag. 126
RACING
- CERNIERE _____ Pag. 122
ZIPPERS
- TENDITORI, CAVETTI E ROTAIE _____ Pag. 102
STRAPS, TURNBUCKLES & RAILS
- BRACCI DI RINFORZO _____ Pag. 100
STRUTS
- TELI DI PROLUNGA _____ Pag. 118
EXTENSION CANVASES

INFO



Peso medio
Kg 15
Medium weight
Kg 15



Velocità consigliata
Max 25 Nodi
Recommended speed
Max 25 Knots

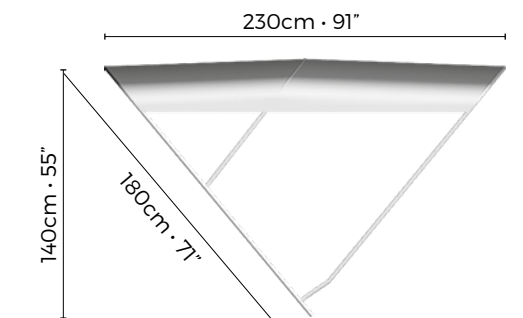

ALTEZZA 140cm • HEIGHT (55")

Codice Code	Larghezza cm Width (inches)
TE07-E02F	170 (67")
TE07-E03F	185 (73")
TE07-E04F	200 (79")
TE07-E05F	215 (85")
TE07-E06F	230 (91")
TE07-E07F	245 (96")

Note Possibilità di realizzazioni fuori misura standard • **Note** Possibility of custom-made realizations

CHIC 4 ARCHI 4 ARCHES



1
Tubo
Verniciato bianco in lega di alluminio-magnesio-silicio Ø 25mm. Attacchi e viteria in acciaio inox 316
Tube
Ø 25mm white lacquered aluminium-magnesium-silicon alloy. Joints and screws in 316 stainless steel



2
Telaio
Smontabile per il trasporto
Frame
Can be disassembled for transport



3
Telo
Tessuto 100% poliestere resinato, bordo in tinta
Canvas
100% resin-coated polyester fabric, matching bordering tape

ACCESSORI DI SERIE • STANDARD ACCESSORIES

Applicazione della custodia sul tendalino
Storage bag application on the Bimini



Custodia
Sacca di custodia con cerniera
Storage bag
Zippered storage bag



Tenditori a nastro
N°1 coppia di tenditori a nastro
Straps
N°1 pair of straps

DIMENSIONI • DIMENSIONS

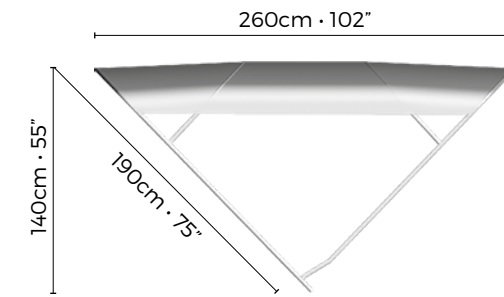
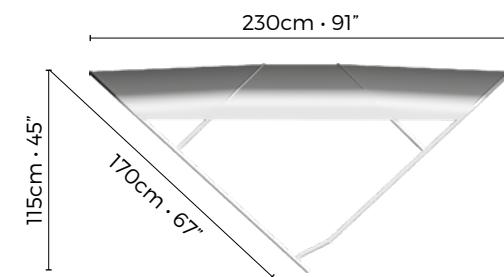

ALTEZZA 115cm • HEIGHT (45")	
Codice Code	Larghezza cm Width (inches)
TE08-B05F	185 (73")
TE08-B06F	200 (79")
TE08-B07F	215 (85")
TE08-B08F	230 (91")
TE08-B09F	245 (96")
TE08-B10F	260 (102")
TE08-B11F	275 (108")
TE08-B12F	290 (114")

ALTEZZA 140cm • HEIGHT (55")	
Codice Code	Larghezza cm Width (inches)
TE08-E03H	185 (73")
TE08-E04H	200 (79")
TE08-E05H	215 (85")
TE08-E06H	230 (91")
TE08-E07H	245 (96")
TE08-E08H	260 (102")
TE08-E09H	275 (108")
TE08-E10H	290 (114")

Nota Possibilità di realizzazioni fuori misure standard • **Note** Possibility of custom-made realizations

OPTIONAL

- ATTACCHI ACCIAIO INOX _____ Pag. 104
STAINLESS STEEL JOINTS
- LED WATERPROOF _____ Pag. 124
LED WATERPROOF
- LUCE 360° _____ Pag. 125
360° LIGHT
- RACING _____ Pag. 126
RACING
- CERNIERE _____ Pag. 122
ZIPPERS
- TENDITORI, CAVETTI E ROTAIE _____ Pag. 102
STRAPS, TURNBUCKLES & RAILS
- BRACCI DI RINFORZO _____ Pag. 100
STRUTS
- TELI DI PROLUNGA _____ Pag. 118
EXTENSION CANVASES

INFO

KG Peso medio
Kg 12
Medium weight
Kg 12

Velocità consigliata
Max 20 Nodi
Recommended speed
Max 20 Knots



CHIC 3 ARCHI 3 ARCHES



1
Tubo
Verniciato bianco in lega di alluminio-magnesio-silicio Ø 25mm. Attacchi e viteria in acciaio inox 316
Tube
Ø 25mm white lacquered aluminium-magnesium-silicon alloy. Joints and screws in 316 stainless steel



2
Telaio
Smontabile per il trasporto
Frame
Can be disassembled for transport



3
Telo
Tessuto 100% poliestere resinato, bordo in tinta
Canvas
100% resin-coated polyester fabric, matching bordering tape

MEHLER
TECHNOLOGIES
POLIESTERE
POLYESTER

ACCESSORI DI SERIE • STANDARD ACCESSORIES

Applicazione della custodia sul tendalino
Storage bag application on the Bimini



Custodia
Sacca di custodia con cerniera
Storage bag
Zippered storage bag



Tenditori a nastro
N°1 coppia di tenditori a nastro
Straps
N°1 pair of straps

DIMENSIONI • DIMENSIONS

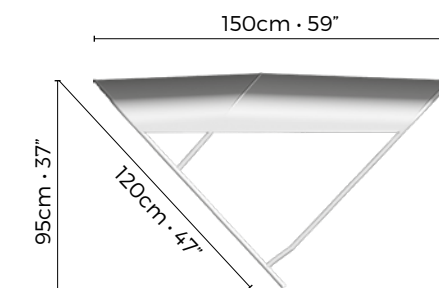

ALTEZZA 95cm • HEIGHT (37")

Codice Code	Larghezza cm Width (inches)
TE09-A01A	150 (59")
TE09-A02A	170 (67")
TE09-A03A	185 (73")
TE09-A04A	200 (79")
TE09-A05A	215 (85")

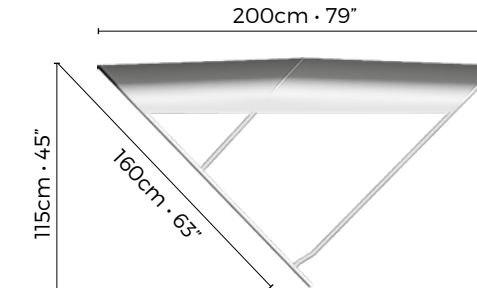

ALTEZZA 115cm • HEIGHT (45")

Codice Code	Larghezza cm Width (inches)
TE09-B04D	170 (67")
TE09-B05D	185 (73")
TE09-B06D	200 (79")
TE09-B07D	215 (85")
TE09-B08D	230 (91")
TE09-B09D	245 (96")

OPTIONAL

- ATTACCHI ACCIAIO INOX _____ Pag. 104
STAINLESS STEEL JOINTS
- LED WATERPROOF _____ Pag. 124
LED WATERPROOF
- LUCE 360° _____ Pag. 125
360° LIGHT
- RACING _____ Pag. 126
RACING
- CERNIERE _____ Pag. 122
ZIPPERS
- TENDITORI, CAVETTI E ROTAIE _____ Pag. 102
STRAPS, TURNBUCKLES & RAILS
- BRACCI DI RINFORZO _____ Pag. 100
STRUTS
- TELI DI PROLUNGA _____ Pag. 118
EXTENSION CANVASES

INFO

KG Peso medio
Kg 10
Medium weight
Kg 10

Velocità consigliata
Max 18 Nodi
Recommended speed
Max 18 Knots

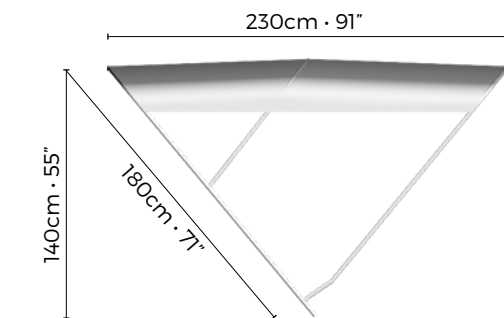

ALTEZZA 140cm • HEIGHT (55")

Codice Code	Larghezza cm Width (inches)
TE09-E02F	170 (67")
TE09-E03F	185 (73")
TE09-E04F	200 (79")
TE09-E05F	215 (85")
TE09-E06F	230 (91")
TE09-E07F	245 (96")

SPORT PLUS 4 ARCHI 4 ARCHES

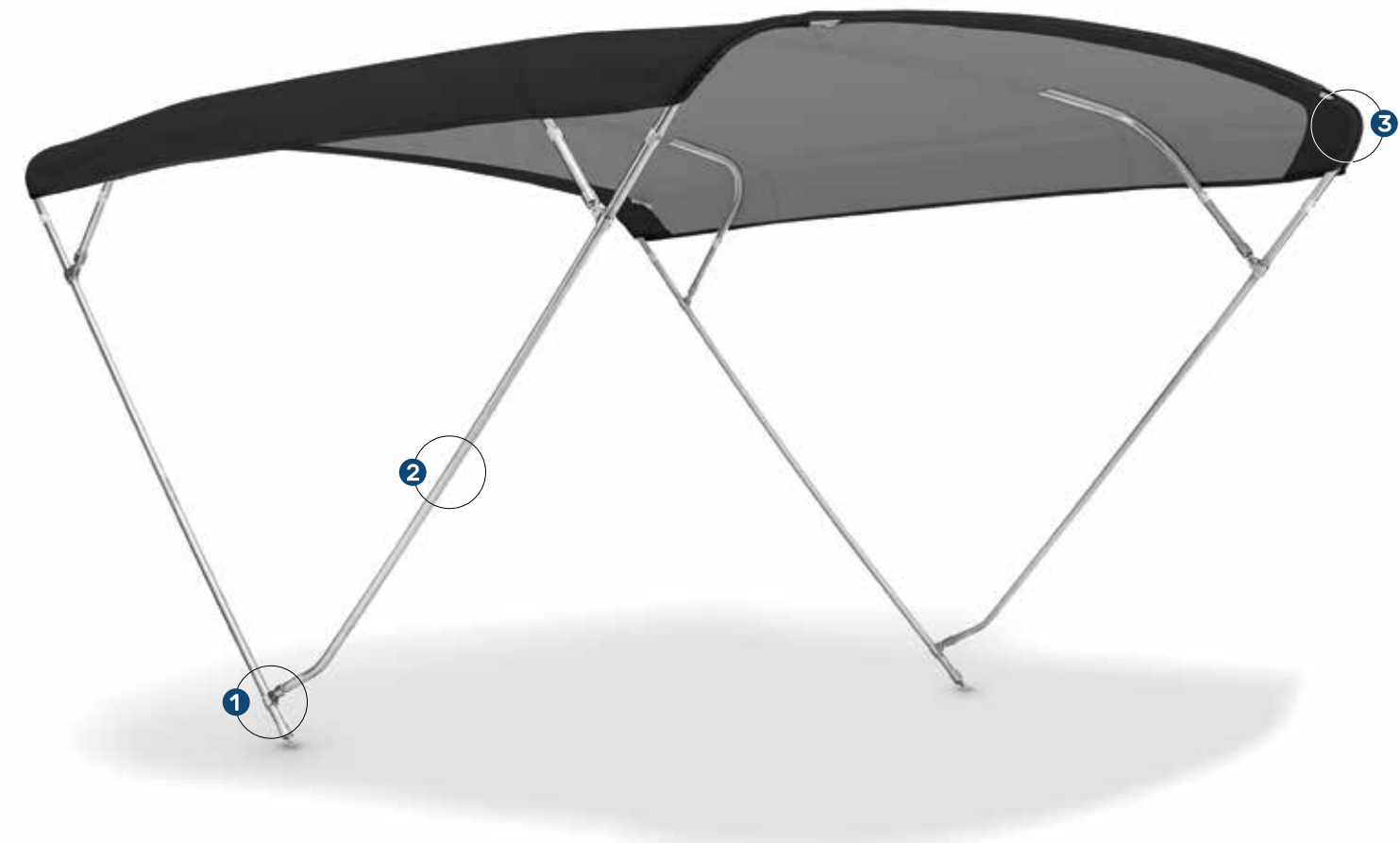

1
Tubo
Acciaio inox lucido 316L Ø 20mm.
Attacchi e viteria in acciaio inox 316
Tube
Ø 20mm polished stainless steel.
Joints and screws in 316 stainless steel



2
Telaio
Smontabile per il trasporto
Frame
Can be disassembled
for transport



3
Telo
Tessuto 100% poliestere resinato,
bordo in tinta
Canvas
100% resin-coated polyester fabric,
matching bordering tape

ACCESSORI DI SERIE • STANDARD ACCESSORIES



Custodia
Sacca di custodia con chiusura a strappo
Storage bag
Velcro closure storage bag



Corda
10 metri di corda
Rope
10 meters of rope



Piastrine tendicorda
N°4 Piastrine tendicorda in acciaio inox
Rope tensioner plates
N°4 stainless steel rope tensioner plates

DIMENSIONI • DIMENSIONS

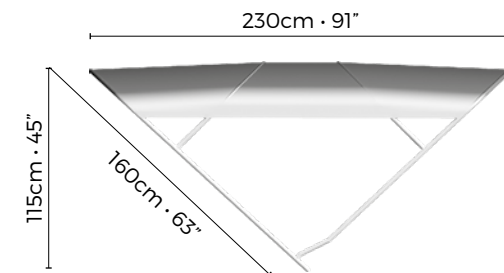

ALTEZZA 115cm • HEIGHT (45")	
Codice Code	Larghezza cm Width (inches)
TE10-B03F	150 (59")
TE10-B04F	170 (67")
TE10-B05F	185 (73")
TE10-B06F	200 (79")
TE10-B07F	215 (85")

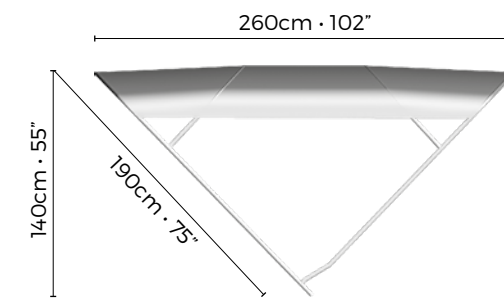

ALTEZZA 140cm • HEIGHT (55")	
Codice Code	Larghezza cm Width (inches)
TE10-E01H	150 (59")
TE10-E02H	170 (67")
TE10-E03H	185 (73")
TE10-E04H	200 (79")
TE10-E05H	215 (85")

Nota Possibilità di realizzazioni fuori misure standard • **Note** Possibility of custom-made realizations

OPTIONAL

- ATTACCHI ACCIAIO INOX _____ Pag. 104
STAINLESS STEEL JOINTS
- LED WATERPROOF _____ Pag. 124
LED WATERPROOF
- RACING _____ Pag. 126
RACING
- CERNIERE _____ Pag. 122
ZIPPERS
- TENDITORI, CAVETTI E ROTAIE _____ Pag. 102
STRAPS, TURNBUCKLES & RAILS
- BRACCI DI RINFORZO _____ Pag. 100
STRUTS
- TELI DI PROLUNGA _____ Pag. 118
EXTENSION CANVASES

INFO

KG **Peso medio**
Kg 10
Medium weight
Kg 10

Velocità consigliata
Max 22 Nodi
Recommended speed
Max 22 Knots



SPORT PLUS 3 ARCHI 3 ARCHES



1
Tubo
Acciaio inox lucido 316L ø 20mm.
Attacchi e viteria in acciaio inox 316
Tube
ø 20mm polished stainless steel.
Joints and screws in 316 stainless steel



2
Telaio
Smontabile per il trasporto
Frame
Can be disassembled
for transport



3
Telo
Tessuto 100% poliestere resinato,
bordo in tinta
Canvas
100% resin-coated polyester fabric,
matching bordering tape

ACCESSORI DI SERIE • STANDARD ACCESSORIES



Custodia
Sacca di custodia con chiusura a strappo
Storage bag
Velcro closure storage bag



Corda
10 metri di corda
Rope
10 meters of rope



Piastrine tendicorda
N°4 Piastrine tendicorda in acciaio inox
Rope tensioner plates
N°4 stainless steel rope tensioner plates

DIMENSIONI • DIMENSIONS

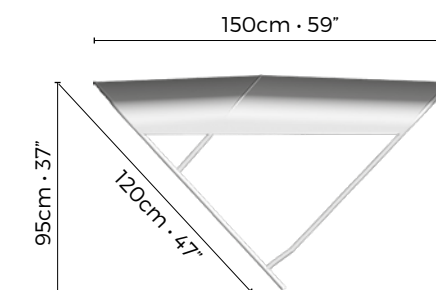

ALTEZZA 95cm • HEIGHT (37")	
Codice Code	Larghezza cm Width (inches)
TE11-A01A	150 (59")
TE11-A02A	170 (67")
TE11-A03A	185 (73")
TE11-A04A	200 (79")
TE11-A05A	215 (85")

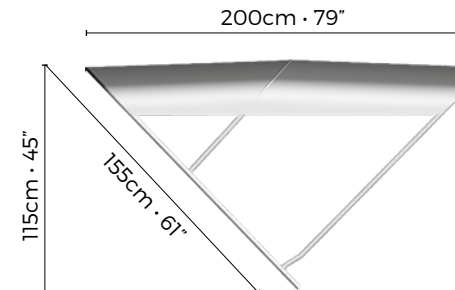

ALTEZZA 115cm • HEIGHT (45")	
Codice Code	Larghezza cm Width (inches)
TE11-B03D	150 (59")
TE11-B04D	170 (67")
TE11-B05D	185 (73")
TE11-B06D	200 (79")
TE11-B07D	215 (85")

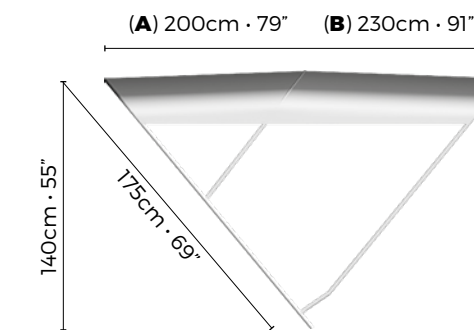

ALTEZZA 140cm • HEIGHT (55")		
Codice Code	Dimensioni • Dimensions	
	Larghezza • (Width)	
TE11-E01D	150 (59")	(A) 200 (79")
TE11-E02D	170 (67")	(A) 200 (79")
TE11-E03F	185 (73")	(B) 230 (91")
TE11-E04F	200 (79")	(B) 230 (91")
TE11-E05F	215 (85")	(B) 230 (91")

Nota Possibilità di realizzazioni fuori misure standard • **Note** Possibility of custom-made realizations

OPTIONAL

- ATTACCHI ACCIAIO INOX _____ Pag. 104
STAINLESS STEEL JOINTS
- LED WATERPROOF _____ Pag. 124
LED WATERPROOF
- RACING _____ Pag. 126
RACING
- CERNIERE _____ Pag. 122
ZIPPERS
- TENDITORI, CAVETTI E ROTAIE _____ Pag. 102
STRAPS, TURNBUCKLES & RAILS
- BRACCI DI RINFORZO _____ Pag. 100
STRUTS
- TELI DI PROLUNGA _____ Pag. 118
EXTENSION CANVASES

INFO

KG Peso medio
Kg 12
Medium weight
Kg 12

Velocità consigliata
Max 22 Nodi
Recommended speed
Max 22 Knots



SPORT 4 ARCHI 4 ARCHES



1
Tubo
Acciaio inox lucido 316L Ø 20mm.
Attacchi in nylon nero caricato in fibra di vetro ad elevata resistenza meccanica. Viteria in acciaio inox
Tube
Ø 20mm polished stainless steel.
Black nylon joints reinforced by fibre-glass with high mechanical resistance. Stainless steel screws



2
Telaio
Smontabile per il trasporto
Frame
Can be disassembled for transport



3
Telo
Tessuto 100% poliestere resinato, bordo in tinta
Canvas
100% resin-coated polyester fabric, matching bordering tape

ACCESSORI DI SERIE • STANDARD ACCESSORIES



Custodia
Sacca di custodia con chiusura a strappo
Storage bag
Velcro closure storage bag

Corda
10 metri di corda
Rope
10 meters of rope



Piedini
N°2 Piedini in nylon nero
Pins
N°2 Black row-lock attachment pins



Boccola
N°2 Boccole in nylon nero
Row-lock attachments
N°2 Black nylon row-lock attachments



Piastrine tendicorda
N°4 Piastrine tendicorda in acciaio inox
Rope tensioner plates
N°4 stainless steel rope tensioner plates

DIMENSIONI • DIMENSIONS

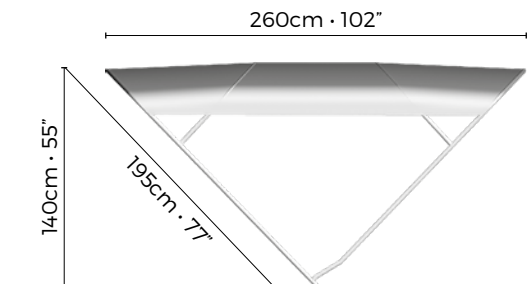
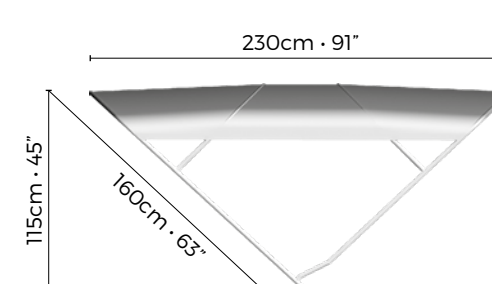

ALTEZZA 115cm • HEIGHT (45")	
Codice Code	Larghezza cm Width (inches)
TE12-B03F	150 (59")
TE12-B04F	170 (67")
TE12-B05F	185 (73")
TE12-B06F	200 (79")
TE12-B07F	215 (85")

ALTEZZA 140cm • HEIGHT (55")	
Codice Code	Larghezza cm Width (inches)
TE12-E01H	150 (59")
TE12-E02H	170 (67")
TE12-E03H	185 (73")
TE12-E04H	200 (79")
TE12-E05H	215 (85")

Nota Possibilità di realizzazioni fuori misure standard • **Note** Possibility of custom-made realizations

OPTIONAL

ATTACCHI NYLON _____ Pag. 108
 NYLON JOINTS
 LED WATERPROOF _____ Pag. 124
 LED WATERPROOF
 RACING _____ Pag. 126
 RACING
 CERNIERE _____ Pag. 122
 ZIPPERS
 TENDITORI _____ Pag. 102
 STRAPS
 BRACCI DI RINFORZO _____ Pag. 100
 STRUTS
 TELI DI PROLUNGA _____ Pag. 118
 EXTENSION CANVASES

INFO

KG Peso medio
Kg 9
Medium weight
Kg 9

Velocità consigliata
Max 18 Nodi
Recommended speed
Max 18 Knots



SPORT 3 ARCHI 3 ARCHES



1
Tubo
Acciaio inox lucido 316L Ø 20mm.
Attacchi in nylon nero caricato in
fibra di vetro ad elevata resistenza
meccanica. Viteria in acciaio inox
Tube
Ø 20mm polished stainless steel.
Black nylon joints reinforced by
fibreglass with high mechanical
resistance. Stainless steel screws



2
Telaio
Smontabile per il trasporto
Frame
Can be disassembled
for transport

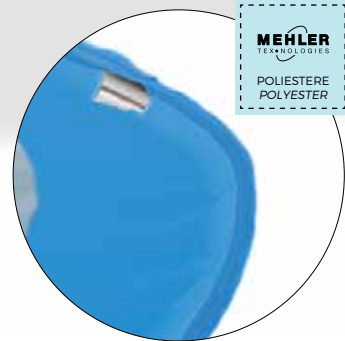

3
Telo
Tessuto 100% poliestere resinato,
bordo in tinta
Canvas
100% resin-coated polyester fabric,
matching bordering tape

ACCESSORI DI SERIE • STANDARD ACCESSORIES



Custodia
Sacca di custodia con chiusura a strappo
Storage bag
Velcro closure storage bag

Corda
10 metri di corda
Rope
10 meters of rope



Piedini
N°2 Piedini in nylon nero
Pins
N°2 Black row-lock attachment pins



Boccola
N°2 Boccole in nylon nero
Row-lock attachments
N°2 Black nylon row-lock attachments



Piastrine tendicorda
N°4 Piastrine tendicorda in acciaio inox
Rope tensioner plates
N°4 stainless steel rope tensioner plates

OPTIONAL

ATTACCHI NYLON _____ Pag. 108
NYLON JOINTS

LED WATERPROOF _____ Pag. 124
LED WATERPROOF

RACING _____ Pag. 126
RACING

CERNIERE _____ Pag. 122
ZIPPERS

TENDITORI _____ Pag. 102
STRAPS

BRACCI DI RINFORZO _____ Pag. 100
STRUTS

TELI DI PROLUNGA _____ Pag. 118
EXTENSION CANVASES

INFO



Peso medio
Kg 8
Medium weight
Kg 8



Velocità consigliata
Max 18 Nodi
Recommended speed
Max 18 Knots



DIMENSIONI • DIMENSIONS

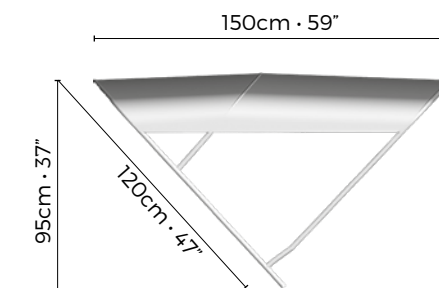

ALTEZZA 95cm • HEIGHT (37")	
Codice Code	Larghezza cm Width (inches)
TE13-A01A	150 (59")
TE13-A02A	170 (67")
TE13-A03A	185 (73")
TE13-A04A	200 (79")
TE13-A05A	215 (85")

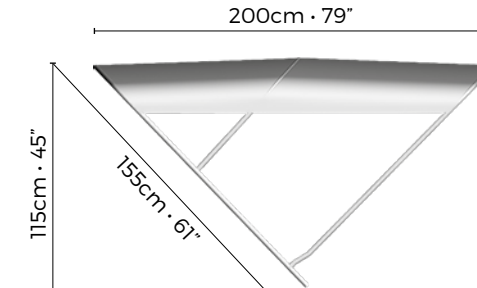

ALTEZZA 115cm • HEIGHT (45")	
Codice Code	Larghezza cm Width (inches)
TE13-B03D	150 (59")
TE13-B04D	170 (67")
TE13-B05D	185 (73")
TE13-B06D	200 (79")
TE13-B07D	215 (85")

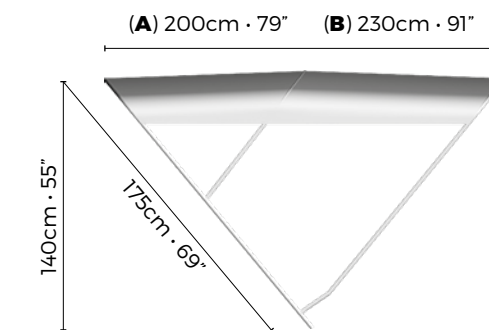

ALTEZZA 140cm • HEIGHT (55")		
Codice Code	Dimensioni • Dimensions	
	Larghezza • (Width)	
TE13-E01D	150 (59")	(A) 200 (79")
TE13-E02D	170 (67")	(A) 200 (79")
TE13-E03F	185 (73")	(B) 230 (91")
TE13-E04F	200 (79")	(B) 230 (91")
TE13-E05F	215 (85")	(B) 230 (91")

Nota Possibilità di realizzazioni fuori misure standard • Note Possibility of custom-made realizations

ELEGANCE PLUS 4 ARCHI 4 ARCHES



1
Tubo
Verniciato bianco in lega di alluminio-magnesio-silicio 22mm
Attacchi e viteria in acciaio inox
Tube
22mm white lacquered aluminium-magnesium-silicon alloy. Stainless steel joints and screws

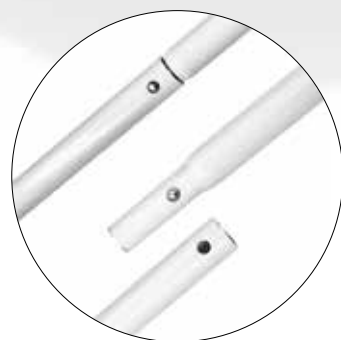

2
Telaio
Smontabile per il trasporto
Frame
Can be disassembled for transport



3
Telo
Tessuto 100% poliestere resinato, bordo in tinta
Canvas
100% resin-coated polyester fabric, matching bordering tape



ACCESSORI DI SERIE • STANDARD ACCESSORIES



Applicazione della custodia sul tendalino
Storage bag application on the Bimini

Custodia
Sacca di custodia con chiusura a strappo
Storage bag
Velcro closure storage bag



Corda
10 metri di corda
Rope
10 meters of rope



Piastrine tendicorda
N°4 Piastrine tendicorda in acciaio inox
Rope tensioner plates
N°4 stainless steel rope tensioner plates

DIMENSIONI • DIMENSIONS

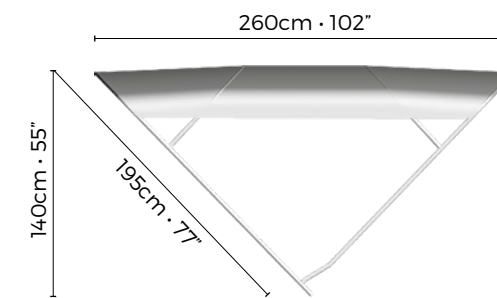
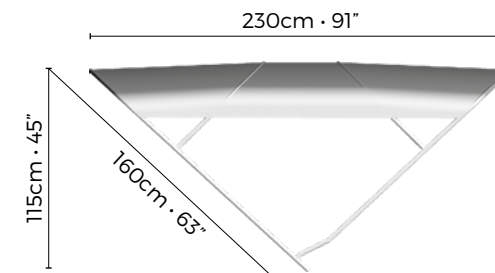

ALTEZZA 115cm • HEIGHT (45")	
Codice Code	Larghezza cm Width (inches)
TE20-B03F	150 (59")
TE20-B04F	170 (67")
TE20-B05F	185 (73")
TE20-B06F	200 (79")
TE20-B07F	215 (85")

ALTEZZA 140cm • HEIGHT (55")	
Codice Code	Larghezza cm Width (inches)
TE20-E01H	150 (59")
TE20-E02H	170 (67")
TE20-E03H	185 (73")
TE20-E04H	200 (79")
TE20-E05H	215 (85")

Nota Possibilità di realizzazioni fuori misure standard • **Note** Possibility of custom-made realizations

OPTIONAL

- ATTACCHI ACCIAIO INOX _____ Pag. 104
STAINLESS STEEL JOINTS
- LED WATERPROOF _____ Pag. 124
LED WATERPROOF
- RACING _____ Pag. 126
RACING
- CERNIERA SU BORDO _____ Pag. 122
ZIPPER ON EDGE
- TENDITORI _____ Pag. 102
STRAPS
- BRACCI DI RINFORZO _____ Pag. 100
STRUTS
- TELI DI PROLUNGA _____ Pag. 118
EXTENSION CANVASES

INFO



Peso medio
Kg 12
Medium weight
Kg 12



Velocità consigliata
Max 20 Nodi
Recommended speed
Max 20 Knots



ELEGANCE PLUS 3 ARCHI 3 ARCHES



1
Tubo
Verniciato bianco in lega di alluminio-magnesio-silicio 22mm
Attacchi e viteria in acciaio inox
Tube
22mm white lacquered aluminium-magnesium-silicon alloy. Stainless steel joints and screws



2
Telaio
Smontabile per il trasporto
Frame
Can be disassembled for transport



3
Telo
Tessuto 100% poliestere resinato, bordo in tinta
Canvas
100% resin-coated polyester fabric, matching bordering tape

ACCESSORI DI SERIE • STANDARD ACCESSORIES



Custodia
Sacca di custodia con chiusura a strappo
Storage bag
Velcro closure storage bag



Corda
10 metri di corda
Rope
10 meters of rope



Piastrine tendicorda
N°4 Piastrine tendicorda in acciaio inox
Rope tensioner plates
N°4 stainless steel rope tensioner plates

DIMENSIONI • DIMENSIONS

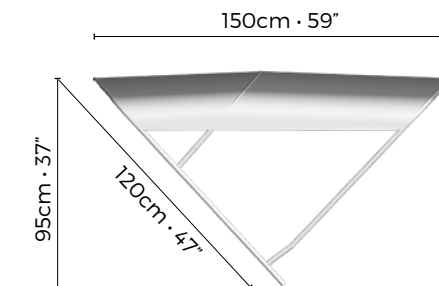

ALTEZZA 95cm • HEIGHT (37")	
Codice Code	Larghezza cm Width (inches)
TE19-A01A	150 (59")
TE19-A02A	170 (67")
TE19-A03A	185 (73")
TE19-A04A	200 (79")
TE19-A05A	215 (85")

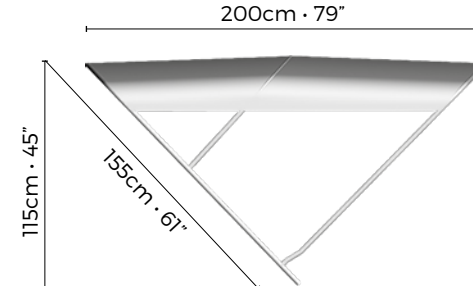

ALTEZZA 115cm • HEIGHT (45")	
Codice Code	Larghezza cm Width (inches)
TE19-B03D	150 (59")
TE19-B04D	170 (67")
TE19-B05D	185 (73")
TE19-B06D	200 (79")
TE19-B07D	215 (85")

OPTIONAL

- ATTACCHI ACCIAIO INOX _____ Pag. 104
STAINLESS STEEL JOINTS
- LED WATERPROOF _____ Pag. 124
LED WATERPROOF
- RACING _____ Pag. 126
RACING
- CERNIERA SU BORDO _____ Pag. 122
ZIPPER ON EDGE
- TENDITORI _____ Pag. 102
STRAPS
- BRACCI DI RINFORZO _____ Pag. 100
STRUTS
- TELI DI PROLUNGA _____ Pag. 118
EXTENSION CANVASES

INFO



Peso medio
Kg 10
Medium weight
Kg 10



Velocità consigliata
Max 20 Nodi
Recommended speed
Max 20 Knots

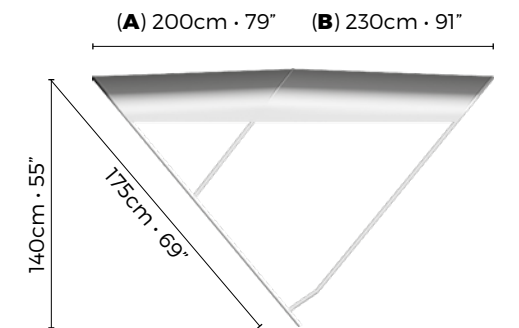

ALTEZZA 140cm • HEIGHT (55")		
Codice Code	Dimensioni • Dimensions	
	Larghezza • (Width)	
TE19-E01D	150 (59")	(A) 200 (79")
TE19-E02D	170 (67")	(A) 200 (79")
TE19-E03F	185 (73")	(B) 230 (91")
TE19-E04F	200 (79")	(B) 230 (91")
TE19-E05F	215 (85")	(B) 230 (91")

Nota Possibilità di realizzazioni fuori misure standard • **Note** Possibility of custom-made realizations

ELEGANCE 3 ARCHI 3 ARCHES



1
Tubo
Verniciato bianco in lega di alluminio-magnesio-silicio Ø 20mm
Attacchi in nylon bianco caricato in fibra di vetro ad elevata resistenza meccanica. Viteria inox e alluminio
Tube
Ø 20mm white lacquered aluminium-magnesium-silicon alloy. White nylon joints reinforced by fibreglass with high mechanical resistance. Stainless steel and aluminium screws



2
Telaio
Ripiegabile.
Dimensioni ripiegato:
Larghezza x 40 x 8cm
Frame
Foldable.
Folded dimensions:
Width x 40cm (16") x 8cm(3")

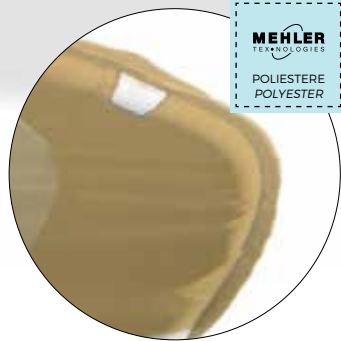

3
Telo
Tessuto 100% poliestere resinato, bordo in tinta
Canvas
100% resin-coated polyester fabric, matching bordering tape

ACCESSORI DI SERIE • STANDARD ACCESSORIES



Custodia
Sacca di custodia con chiusura a strappo
Storage bag
Velcro closure storage bag

Corda
10 metri di corda
Rope
10 meters of rope

Piedini
N°2 Piedini in nylon bianco
Pins
N°2 White row-lock attachment pins

Boccola
N°2 Boccole in nylon bianco
Row-lock attachments
N°2 White nylon row-lock attachments

Piastrine tendicorda
N°4 Piastrine tendicorda in acciaio inox
Rope tensioner plates
N°4 stainless steel rope tensioner plates

DIMENSIONI • DIMENSIONS

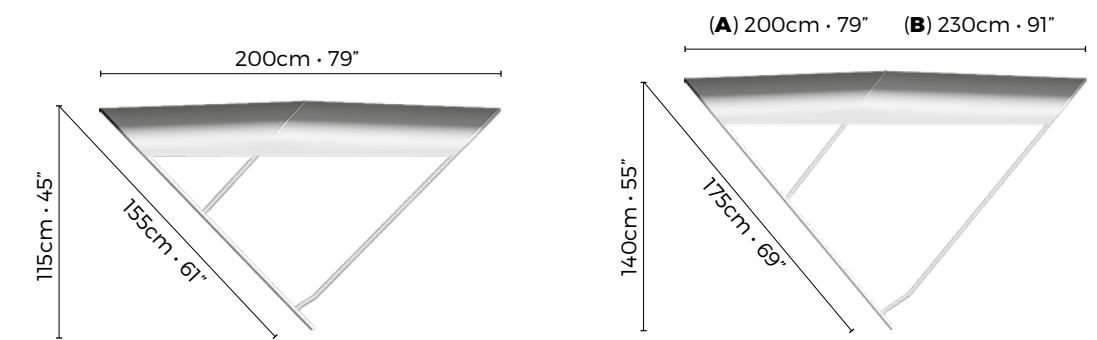

ALTEZZA 115cm • HEIGHT (45")	
Codice Code	Larghezza cm Width (inches)
TE14-B03D	150 (59")
TE14-B04D	170 (67")
TE14-B05D	185 (73")
TE14-B06D	200 (79")
TE14-B07D	215 (85")

ALTEZZA 140cm • HEIGHT (55")		
Codice Code	Dimensioni • Dimensions	
	Larghezza • (Width)	
TE14-E01D	150 (59")	(A) 200 (79")
TE14-E02D	170 (67")	(A) 200 (79")
TE14-E03F	185 (73")	(B) 230 (91")
TE14-E04F	200 (79")	(B) 230 (91")
TE14-E05F	215 (85")	(B) 230 (91")

Nota Possibilità di realizzazioni fuori misure standard • **Note** Possibility of custom-made realizations

OPTIONAL

- ATTACCHI NYLON _____ Pag. 108
NYLON JOINTS
- LED WATERPROOF _____ Pag. 124
LED WATERPROOF
- RACING _____ Pag. 126
RACING
- CERNIERA SU BORDO _____ Pag. 122
ZIPPER ON EDGE
- TENDITORI _____ Pag. 102
STRAPS
- BRACCI DI RINFORZO _____ Pag. 100
STRUTS
- TELI DI PROLUNGA _____ Pag. 118
EXTENSION CANVASES

INFO

KG **Peso medio**
Kg 7
Medium weight
Kg 7

Velocità consigliata
Max 15 Nodi
Recommended speed
Max 15 Knots



ELEGANCE 2 ARCHI 2 ARCHES

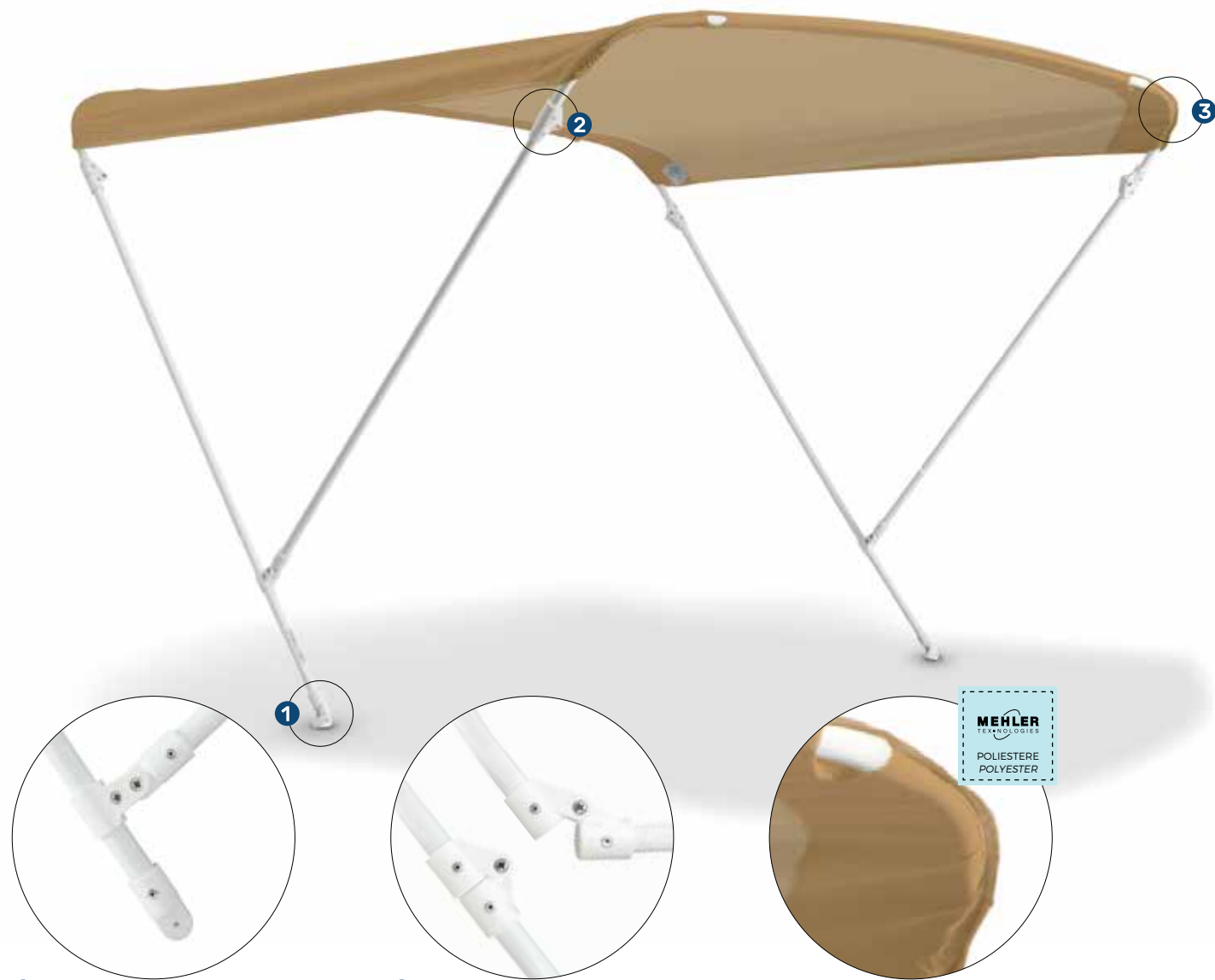

1
Tubo
Verniciato bianco in lega di alluminio-magnesio-silicio Ø 20mm
Attacchi in nylon bianco caricato in fibra di vetro ad elevata resistenza meccanica. Viteria inox e alluminio
Tube
Ø 20mm white lacquered aluminium-magnesium-silicon alloy. White nylon joints reinforced by fibreglass with high mechanical resistance. Stainless steel and aluminium screws

2
Telaio
Ripiegabile.
Dimensioni ripiegato:
Larghezza x 40 x 8cm
Frame
Foldable.
Folded dimensions:
Width x 40cm (16") x 8cm(3")

3
Telo
Tessuto 100% poliestere resinato, bordo in tinta
Canvas
100% resin-coated polyester fabric, matching bordering tape



ACCESSORI DI SERIE • STANDARD ACCESSORIES



Custodia
Sacca di custodia con chiusura a strappo
Storage bag
Velcro closure storage bag

Corda
10 metri di corda
Rope
10 meters of rope

Piedini
N°2 Piedini in nylon bianco
Pins
N°2 White row-lock attachment pins

Boccola
N°2 Boccole in nylon bianco
Row-lock attachments
N°2 White nylon row-lock attachments

Piastrine tendicorda
N°4 Piastrine tendicorda in acciaio inox
Rope tensioner plates
N°4 stainless steel rope tensioner plates

DIMENSIONI • DIMENSIONS

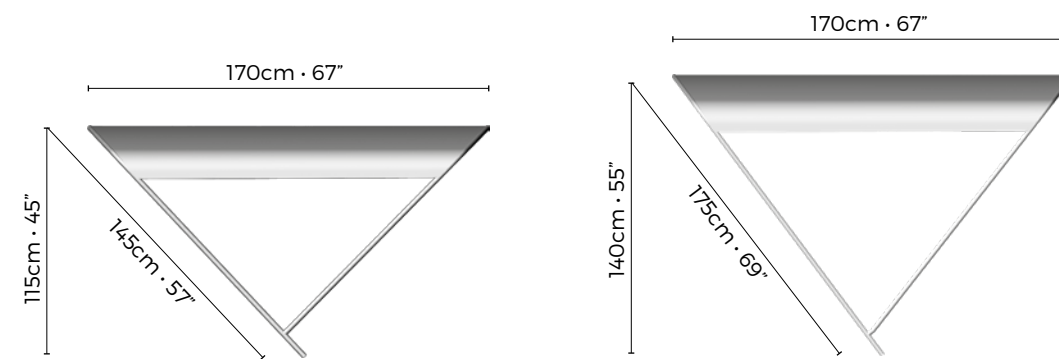

ALTEZZA 115cm • HEIGHT (45")	
Codice Code	Larghezza cm Width (inches)
TE15-B01B	110 (43")
TE15-B02B	130 (51")
TE15-B03B	150 (59")
TE15-B04B	170 (67")

ALTEZZA 140cm • HEIGHT (55")	
Codice Code	Larghezza cm Width (inches)
TE15-E01B	150 (59")
TE15-E02B	170 (67")
TE15-E03B	185 (73")

Nota Possibilità di realizzazioni fuori misure standard • **Note** Possibility of custom-made realizations

OPTIONAL

ATTACCHI NYLON _____ Pag. 108
NYLON JOINTS
BRACCI DI RINFORZO _____ Pag. 100
STRUTS
TENDITORI _____ Pag. 118
STRAPS

INFO

KG **Peso medio**
Kg 5
Medium weight
Kg 5
Velocità consigliata
Max 12 Nodi
Recommended speed
Max 12 Knots



PRESTIGE 3 ARCHI 3 ARCHES

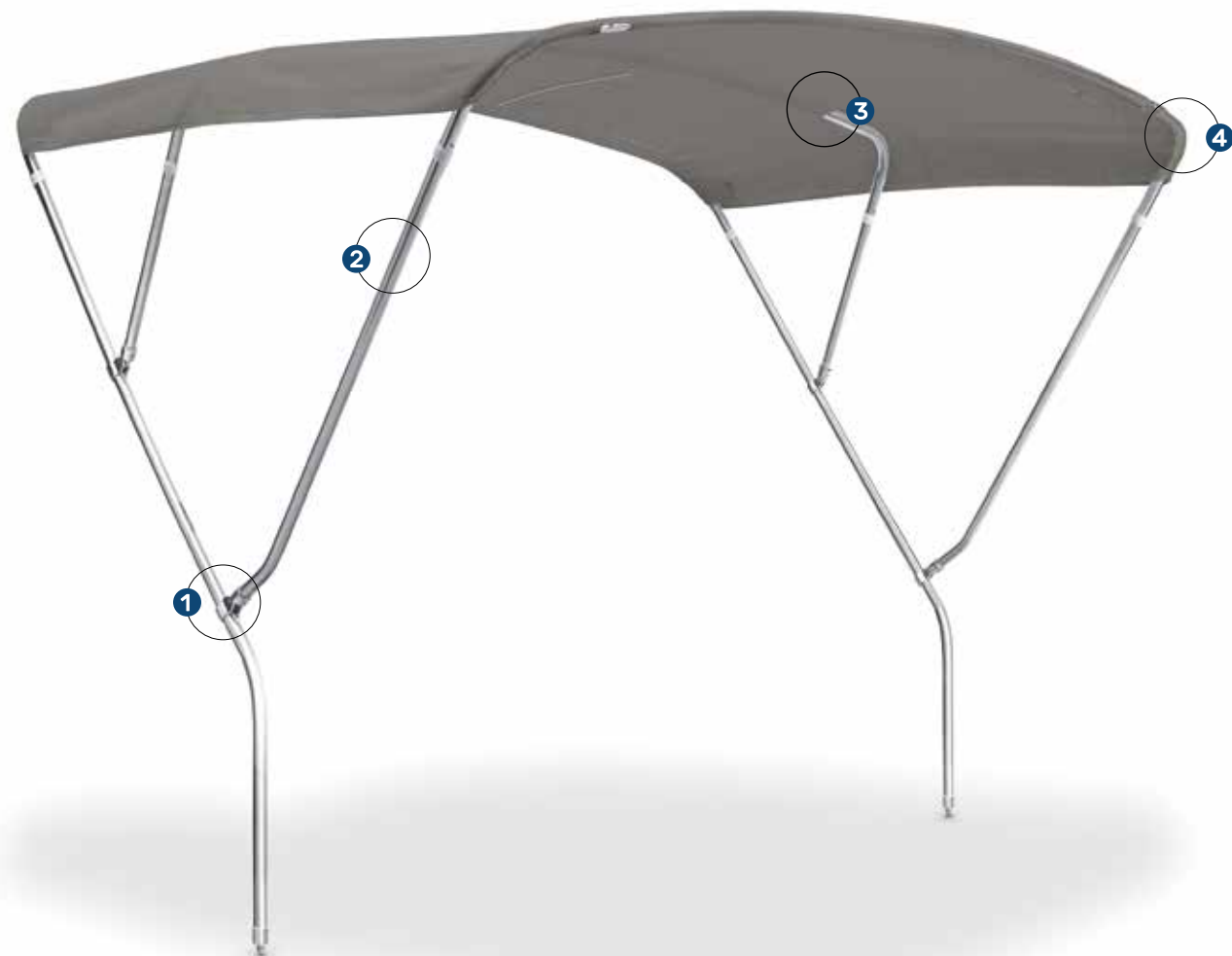

1
Tubo
Acciaio inox lucido 316L Ø 25mm.
Attacchi e viteria acciaio inox 316
Tube
Ø 25mm polished stainless steel.
Joints and screws in 316 stainless steel



2
Telaio
Smontabile per il trasporto
Frame
Can be disassembled
for transport



3
Cerniere sotto archi
Cerniera divisibile catena 8mm YKK
Zippers under arch
Application of 8mm YKK divisibile
zipper on the arch passage pocket

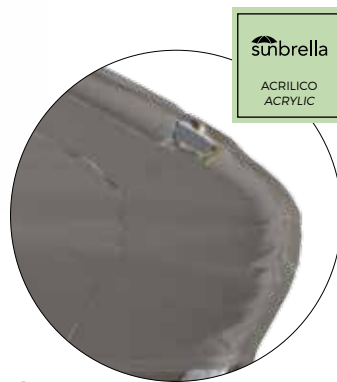

4
Telo
Tessuto 100% acrilico resinato,
bordo in tinta
Canvas
100% resin-coated acrylic fabric,
matching bordering tape

☂
ACRILICO
ACRYLIC

ACCESSORI DI SERIE • STANDARD ACCESSORIES

Applicazione della custodia sul tendalino
Storage bag application on the Bimini

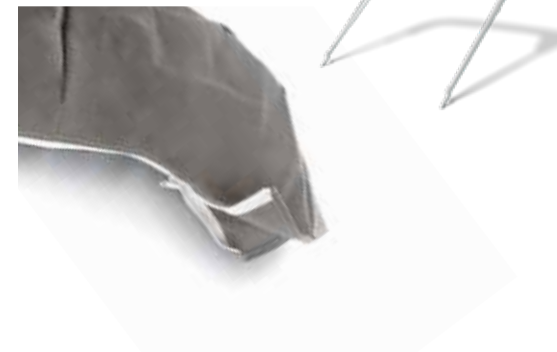

Custodia
Sacca di custodia con cerniera
Storage bag
Zippered storage bag



Tenditori a nastro
N°1 coppia di tenditori a nastro
Straps
N°1 pair of straps

OPTIONAL

- ATTACCHI ACCIAIO INOX _____ Pag. 108
STAINLESS STEEL JOINTS
- LED WATERPROOF _____ Pag. 124
LED WATERPROOF
- CERNIERA SU BORDO _____ Pag. 122
ZIPPER ON EDGE
- TENDITORI, CAVETTI E ROTAIE _____ Pag. 102
STRAPS, TURNBUCKLES & RAILS
- BRACCI DI RINFORZO _____ Pag. 100
STRUTS
- TELI DI PROLUNGA _____ Pag. 118
EXTENSION CANVASES

DIMENSIONI • DIMENSIONS

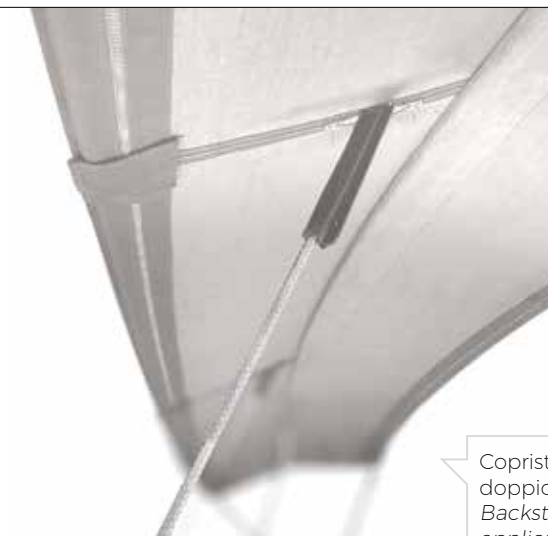
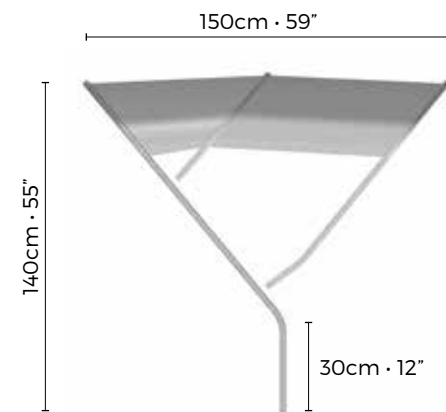

Copristrallo e applicazione cerniera lampo
doppio cursore per passaggio strallo di poppa.
Backstay cover and double-slider zip
application for backstay slot.

INFO



Peso medio
Kg 15
Medium weight
Kg 15



Velocità consigliata
Max 25 Nodi
Recommended speed
Max 25 Knots



ALTEZZA 140cm • HEIGHT (55")

Codice Code	Larghezza cm Width (inches)
TE02-E07A	245 (96")
TE02-E08A	260 (102")
TE02-E09A	275 (108")
TE02-E10A	290 (114")

Nota Possibilità di realizzazioni fuori misure standard
Note Possibility of custom-made realizations



CAGNARO STECCATO

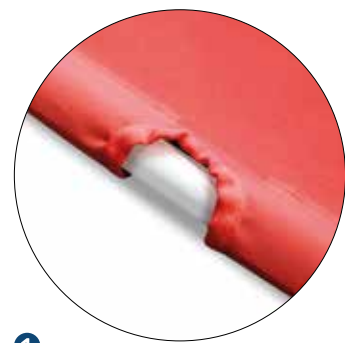
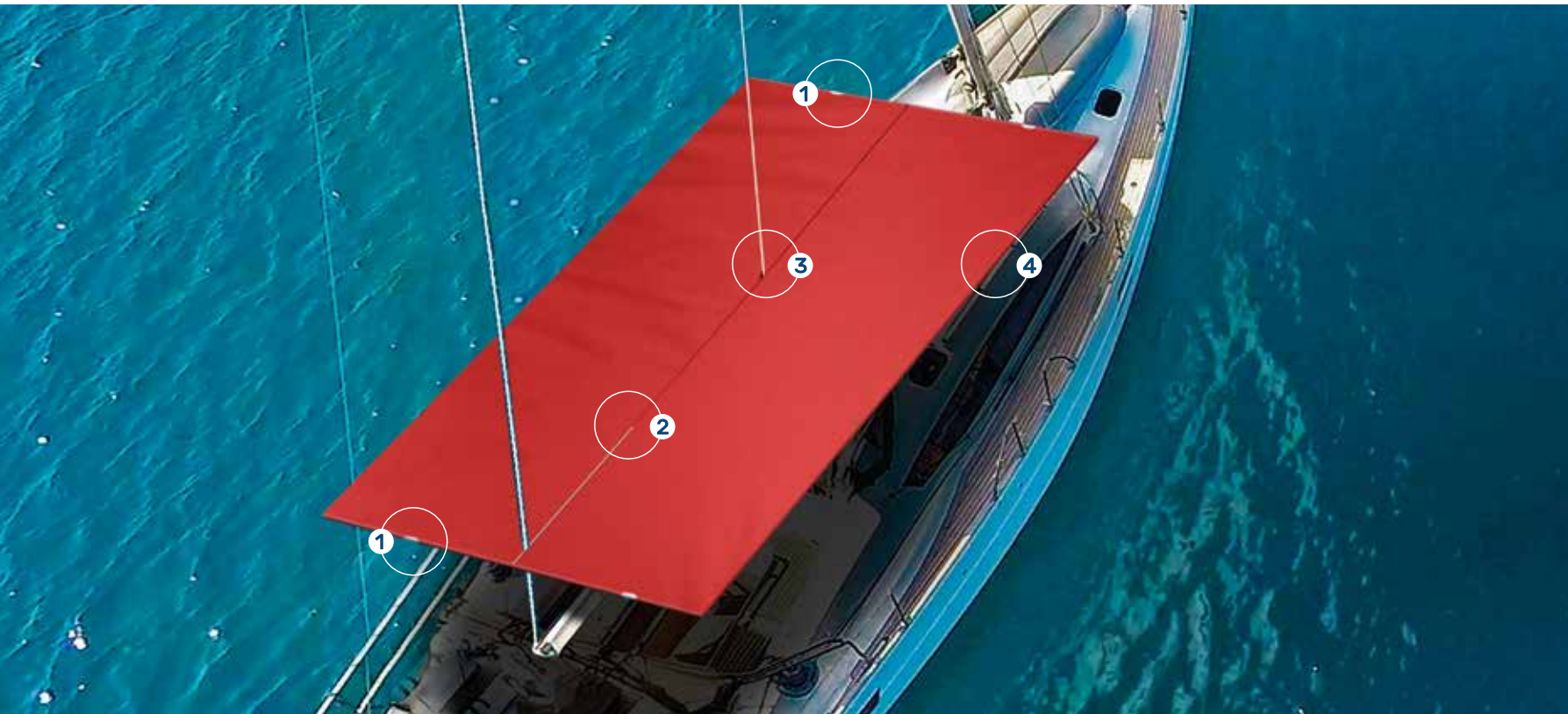

1
Tubo
Tubo in alluminio verniciato bianco Ø20
Tube
Ø 20mm white lacquered aluminium tube



2
Passaggio per amantiglio
con cerniera a doppio cursore
Passageway for topping lift
with double-slider zipper

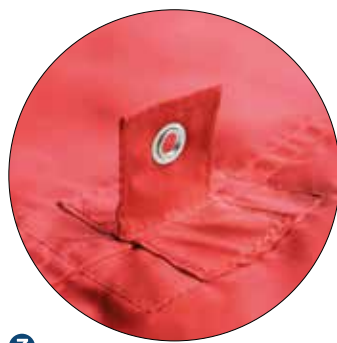

3
Sostegno centrale
con anello in acciaio inox 316
Central support
with stainless steel 316 ring

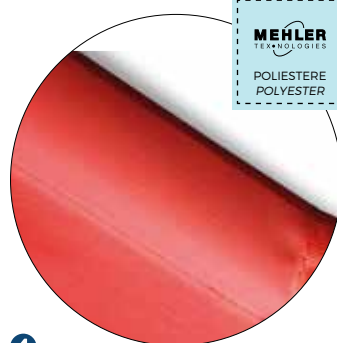

4
Telo
Tessuto 100% poliestere resinato, bordo in tinta
Canvas
100% resin-coated polyester fabric, matching bordering tape

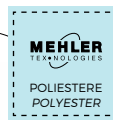

DESCRIZIONE

Il tendalino **CAGNARO STECCATO** è stato progettato per creare ombra sulle **barche a vela** senza dover rinunciare allo spazio a bordo.

Il telaio smontabile in alluminio permette di tenere alto e perfettamente teso il telo senza ingombrare il ponte della barca.

Realizzato in tessuto 100% poliestere resinato assicura un'elevata protezione dai raggi UV e resistenza agli agenti atmosferici marini.

Il telo è provvisto di **passaggio per amantiglio** e di un anello in acciaio inox nella parte centrale per il fissaggio in alto nonché di tre asole in corrispondenza delle tre barre di alluminio che compongono il telaio, da utilizzare per il passaggio della corda di fissaggio.

A discrezione del cliente se utilizzare le due asole laterali o quella centrale.

DESCRIPTION

The **CAGNARO STECCATO** Bimini Top has been designed to create shade on **sailing boats** without having to give up the space on board.

The removable aluminium frame allows to keep the canvas high and perfectly stretched without cluttering the boat deck.

Made of 100% polyester resin fabric, it ensures a high protection against UV rays and resistance to marine atmospheric agents. The canvas is provided with a

zippered slot for the topping lift and a stainless steel ring in the central part for the Bimini Top fixing at the top, as well as three slots in correspondence of the three aluminium bars that make up the frame, to be used for the passage of the fastening rope. For the installation is at the discretion of the customer whether to use the two side slots or the central one together with the ring in the middle of the canvas.



INFO

KG **Peso medio**
Kg 4
Medium weight
Kg 4

Velocità consigliata
Max 15 Nodi
Recommended speed
Max 15 Knots



Codice Code	Dimensioni cm • Dimensions (inches)
	B
TE16-G	250 (98")
TE16-K	300 (118")
TE16-O	350 (138")

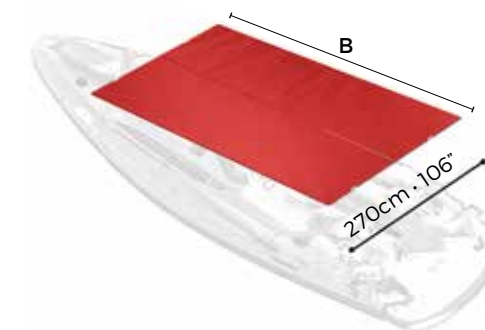

Nota
Possibilità di realizzazioni fuori misure standard
Note
Possibility of custom-made realizations

CAGNARO

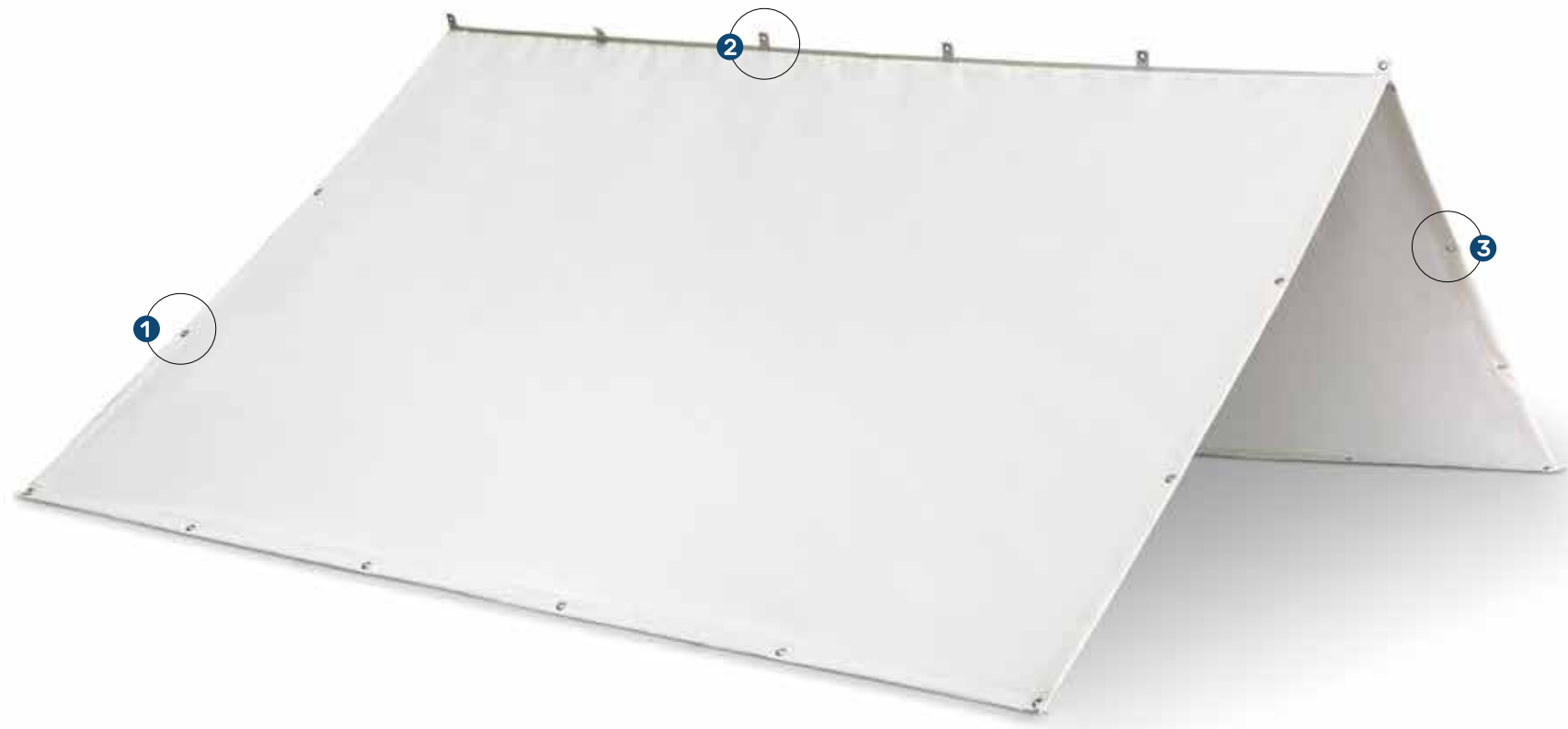

1
Anelli perimetrali
Acciaio inox 316
per fissaggio su draglie
Rings along the perimeter
316 stainless steel
for fixing on lifelines



2
Sostegno centrale
con anelli in acciaio inox 316
Central support
with stainless steel 316 rings

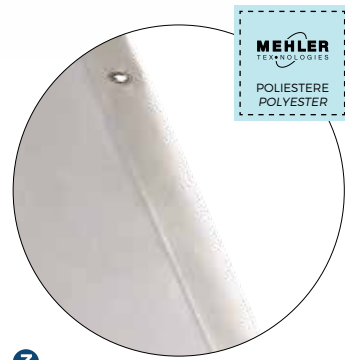

3
Telo
Tessuto 100% poliestere resinato,
bordo in tinta
Canvas
100% resin-coated polyester fabric,
matching bordering tape

DESCRIZIONE

Il tendalino **CAGNARO**, progettato per creare ombra sulle barche a vela, è un telo **leggero e di facile installazione**.
Realizzato in tessuto 100% poliestere resinato, assicura un'elevata protezione dai raggi UV e resistenza agli agenti atmosferici marini.
Il telo è provvisto di **anelli in acciaio inox** lungo il perimetro e lungo la parte centrale, così da permettere sia il fissaggio laterale alle draglie che il fissaggio in alto.

DESCRIPTION

The **CAGNARO** Bimini Top, designed to create shade on sailing boats, is a **light and easy to install** canvas. Made of 100% polyester resin-coated fabric, it ensures a high protection against UV rays and resistance to marine atmospheric agents.
The canvas is provided with **stainless steel rings** along the perimeter and along the central part, so as to allow both the side fixing to the stays and the fixing at the top.



DIMENSIONI • DIMENSIONS

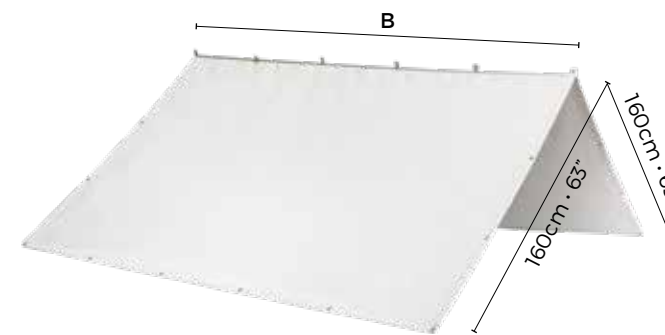

Codice Code	Dimensioni cm • Dimensions (inches)
	B
TE17-G	250 (98")
TE17-I	275 (108")
TE17-K	300 (118")
TE17-M	325 (128")

INFO



Nota
Possibilità di realizzazioni fuori misure standard
Note
Possibility of custom-made realizations

FISHER



1
Tubo
Acciaio inox lucido 316L Ø 25/22mm.
Attacchi e viteria in acciaio inox 316
Tube
Ø 25/22mm polished stainless steel.
Joints and screws in 316 stainless steel

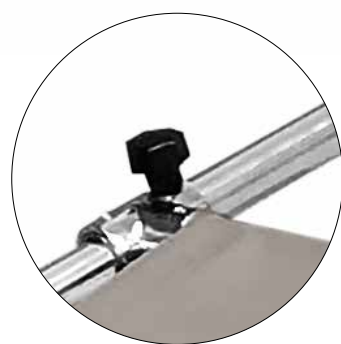

2
Telaio
Estraibile
Frame
Pull-out Bimini Top

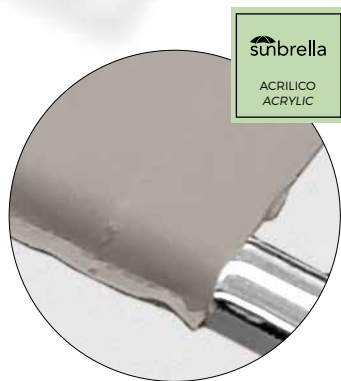

3
Telo
Tessuto 100% acrilico resinato,
bordo in tinta
Canvas
100% resin-coated acrylic fabric,
matching bordering tape



DESCRIZIONE • DESCRIPTION

Avere spazio a bordo è sempre utile, ancor di più se si è su una barca da pesca. Il **tendalino estraibile** modello FISHER ha questa finalità.

Realizzato in **acciaio lucido 316L** e **telo in tessuto acrilico**, se necessario, **crea ombra in pochi istanti evitando inutili ingombri**.

Prodotto su misura secondo il modello di barca.

Nota: Per preventivi indicare le misure A, B e C come da schema.

On a boat is always useful to have space, even more if you are on a fishing boat. The **FISHER model pull-out Bimini Top** has this purpose.

Made of **316L polished stainless steel** and **acrylic fabric canvas**, if necessary, it creates shade in a few moments avoiding unnecessary bulk.

Custom product according to the model of boat.

Note: For quotes, please indicate measures A, B and C as per diagram.

DIMENSIONI • DIMENSIONS

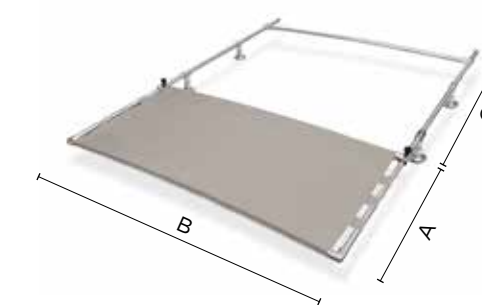

INFO

KG **Peso medio**
Kg 10
Medium weight
Kg 10

Velocità consigliata
Max 15 Nodi
Recommended speed
Max 15 Knots



Codice Code	Dimensioni cm • Dim. (inches)
	B
TE03-C12P	120 (47")
TE03-C13P	130 (51")
TE03-C14P	140 (55")

TENDALINO CON PALI IN CARBONIO

BIMINI TOPS WITH CARBON POLES



1
Palo in carbonio
Ø 38mm disponibile in due altezze
(H.149 cm - H.199 cm)
Carbon Pole
Ø 38mm available in two heights
(H.149 cm - H.199 cm)



2
Boccola da incasso
in acciaio inox completa di tappo
di chiusura rotante a 180°
Recess-fit bushing
stainless steel, equipped with 180°
swivel lock

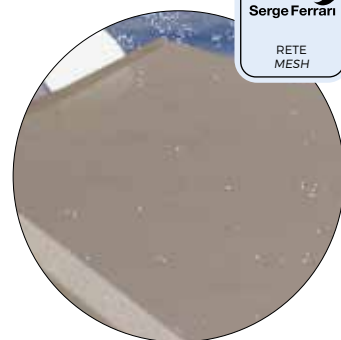

3
Telo
Tessuto 100% acrilico resinato,
bordo in tinta
Canvas
100% resin-coated acrylic fabric,
matching bordering tape

Serge Ferrari
RETE
MESH

DESCRIZIONE • DESCRIPTION

I Bimini con sistema di pali in fibra di carbonio, **disponibili in diverse altezze**, sono progettati per l'utilizzo su barche a motore, barche a vela e gommoni. Si adattano perfettamente al ponte di poppa o di prua ed essendo estremamente leggeri, sono facili da montare e riporre ovunque.

I bicchieri di supporto incassati dritti o inclinati sono dotati di un **tappo di chiusura girevole** da utilizzare quando non in uso e di un foro di drenaggio acqua.

La **rete ombreggiante su misura** adotta un sistema di tensionamento manuale attraverso un Clamcleat (strozzascotte) già montato sul palo.

Bimini systems with carbon fibre poles, **available in different heights**, are designed for use on motor boats, sailing boats and inflatables. They fit perfectly on the aft or bow deck and being extremely light, they are easy to assemble and store anywhere.

The straight or inclined recessed support cups are equipped with a **swivel closing cap** to use when not employed and with a water drain hole.

The **custom made shading mesh** adopts a manual tensioning system through a clamcleat already mounted on the pole.

OPTIONAL

ACCESSORI PALI IN CARBONIO — Pag. 109
CARBON POLES ACCESSORIES



ROLL BARS

I roll bar in acciaio inox Nettuno Marine Equipment® con tendalino incluso sono disponibili in vari modelli per adattarsi perfettamente ad ogni tipologia d'imbarcazione. Oltre al fattore estetico, sono la soluzione ideale per avere **ombra ed accessori integrati**, come luci e strumenti di navigazione.

*The stainless steel roll bars with Bimini Top included are available in a wide range of models to be compatible with various types of boats. Besides to the aesthetic factor, they are the best solution to have **shadow and integrated accessories** like lights and navigation instruments.*

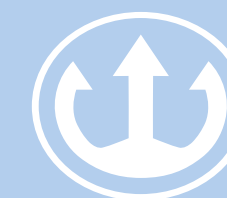

ROLL BARS

02

STRANGE XL 3 ARCHI 3 ARCHES



subrella
ACRILICO
ACRYLIC

5
Telo
Tessuto 100% acrilico resinato,
bordo in tinta
Canvas
100% resin-coated acrylic fabric,
matching bordering tape

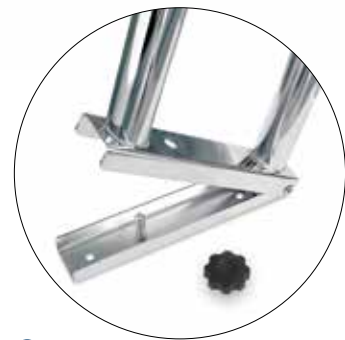

1
Roll bar monotubo
con sistema ribaltabile, tubo Ø40
mm in acciaio inox lucido 316L
Single-tube roll bar
with folding system, Ø40 mm tube
in 316L polished stainless steel



2
Telaio
Arco prua telescopico Ø25/22 mm
e arco centrale Ø22 mm in acciaio
inox lucido 316L
Frame
Ø25/22 mm telescopic bow arch
and Ø22 mm central arch in 316L
polished stainless steel



3
Attacchi e viteria
Acciaio inox 316
Joints and screws
316 Stainless steel

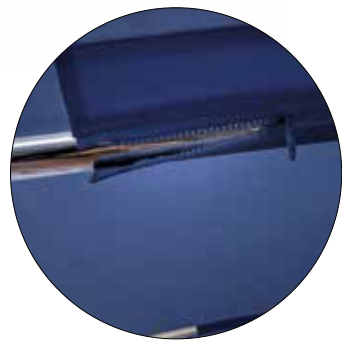

4
Cerniere sotto archi
Cerniera divisibile catena 8mm YKK
Zippers under arch
Application of 8mm YKK divisibile
zipper

ACCESSORI DI SERIE • STANDARD ACCESSORIES

Applicazione della custodia sul roll bar
Storage bag application on the roll bar



Custodia
N°1 Sacca di custodia con cerniera
Storage bag
N°1 Zippered storage bag



Tenditori a nastro
N°1 Coppia di tenditori a nastro
Straps
N°1 Pair of straps

DIMENSIONI • DIMENSIONS

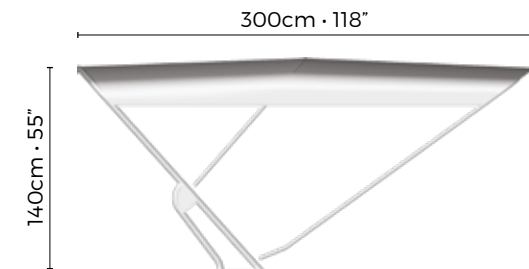

Nota

- 1 Possibilità di realizzazioni fuori misura standard
 - 2 I codici in tabella comprendono roll bar e tendalino
- Note**
1 Possibility of custom-made realizations
2 The codes in the table include roll bar and Bimini

OPTIONAL

- LUCI PER ROLL BAR E T-TOP _____ Pag. 114
ROLL BARS AND T-TOP LIGHTS
- TELI DI PROLUNGA _____ Pag. 118
EXTENSION CANVASES
- CERNIERA SU BORDO _____ Pag. 122
ZIPPER ON EDGE
- RACING _____ Pag. 126
RACING
- CONTROPIASTRE E POMELLI _____ Pag. 112
COUNTERPLATES AND KNOBS

INFO • INFO

KG **Peso medio**
Kg 25
Medium weight
Kg 25

Velocità consigliata
Max 30 Nodi
Recommended speed
Max 30 Knots



ALTEZZA 140cm • HEIGHT (55")

Codice Code	Larghezza cm Width (inches)
RB09-E02K	170 (67")
RB09-E03K	185 (73")
RB09-E04K	200 (79")
RB09-E05K	215 (85")
RB09-E06K	230 (91")
RB09-E07K	245 (96")



STRANGE 3 ARCHI 3 ARCHES



subrella
ACRILICO
ACRYLIC

5
Telo
Tessuto 100% acrilico resinato,
bordo in tinta
Canvas
100% resin-coated acrylic fabric,
matching bordering tape



1
Roll bar monotubo
con sistema ribaltabile, tubo Ø40
mm in acciaio inox lucido 316L
Single-tube roll bar
with folding system, Ø40 mm tube in
316L polished stainless steel

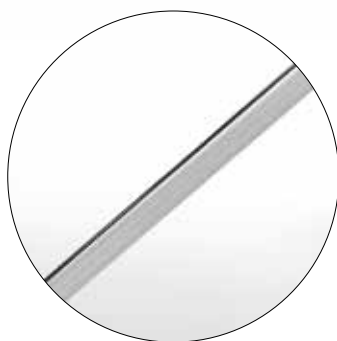

2
Telaio
Archi Ø22 mm in acciaio inox
lucido 316L
Frame
Ø22 mm arches in 316L polished
stainless steel



3
Attacchi e viteria
Acciaio inox 316
Joints and screws
316 stainless steel

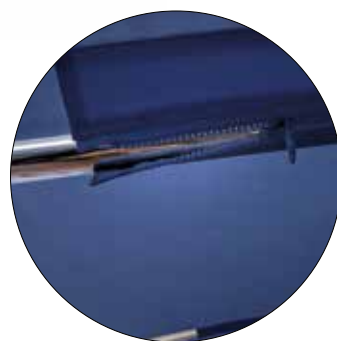

4
Cerniere sotto archi
Cerniera divisibile catena 8mm YKK
Zippers under arch
Application of 8mm YKK divisibile
zipper

ACCESSORI DI SERIE • STANDARD ACCESSORIES



Custodia
N°1 Sacca di custodia con cerniera
Storage bag
N°1 Zippered storage bag

Tenditori a nastro
N°1 Coppia di tenditori a nastro
Straps
N°1 Pair of straps

DIMENSIONI • DIMENSIONS

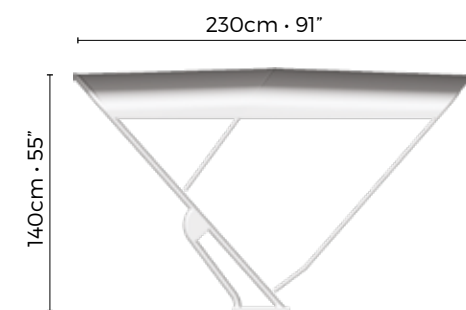

Nota
1 Possibilità di realizzazioni fuori misura standard
2 I codici in tabella comprendono roll bar e tendalino
Note
1 Possibility of custom-made realizations
2 The codes in the table include roll bar and Bimini

OPTIONAL

- LUCI PER ROLL BAR E T-TOP _____ Pag. 114
ROLL BARS AND T-TOP LIGHTS
- TELI DI PROLUNGA _____ Pag. 118
EXTENSION CANVASES
- CERNIERA SU BORDO _____ Pag. 122
ZIPPER ON EDGE
- RACING _____ Pag. 126
RACING
- CONTROPIASTRE E POMELLI _____ Pag. 112
COUNTERPLATES AND KNOBS

INFO • INFO

KG **Peso medio**
Kg 25
Medium weight
Kg 25

Velocità consigliata
Max 30 Nodi
Recommended speed
Max 30 Knots



ALTEZZA 140cm • HEIGHT (55")

Codice Code	Larghezza cm Width (inches)
RB07-E02F	170 (67")
RB07-E03F	185 (73")
RB07-E04F	200 (79")
RB07-E05F	215 (85")
RB07-E06F	230 (91")
RB07-E07F	245 (96")



SUPERIOR



1
Roll bar
con sistema ribaltabile, doppio tubo Ø40 mm in acciaio inox lucido 316L
Roll bar
with folding system, Ø40 mm double tube in 316L polished stainless steel

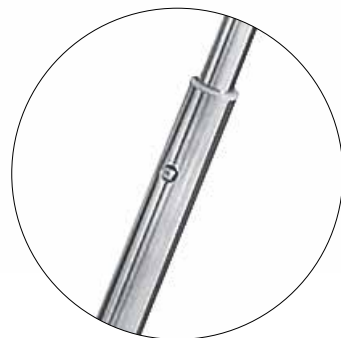

2
Telaio telescopico
Ø25/22 mm in acciaio inox lucido 316L a due archi anteriori e un arco posteriore
Telescopic frame
Ø25/22 mm 316L polished stainless steel with two front arches and one rear

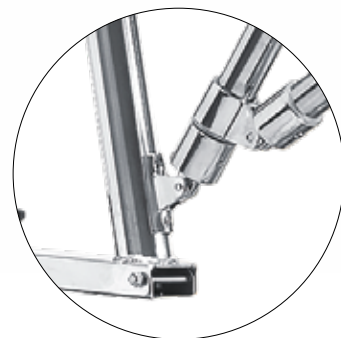

3
Attacchi e viteria
Acciaio inox 316
Joints and screws
in 316 stainless steel



4
Telo
Tessuto 100% acrilico resinato, bordo in tinta
Canvas
100% resin-coated acrylic fabric, matching bordering tape

ACCESSORI DI SERIE • STANDARD ACCESSORIES

Applicazione delle custodie sui tendalini
Storage bags application on the Bimini Tops



Custodie
N°2 Sacche di custodia con cerniera
Storage bags
N°2 Zippered storage bags

Tenditori a nastro
N°2 Coppie di tenditori a nastro
Straps
N°2 Pairs of straps

DIMENSIONI • DIMENSIONS

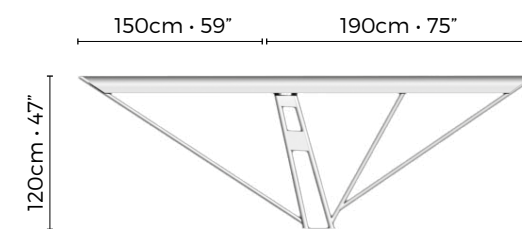

ALTEZZA 120cm • HEIGHT (47")

Codice Code	Larghezza cm Width (inches)
RB04-C03N	170 (67")
RB04-C04N	185 (73")
RB04-C06N	200 (79")
RB04-C07N	215 (85")
RB04-C08N	230 (91")
RB04-C09N	245 (96")

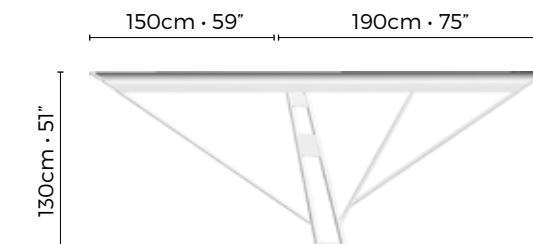

ALTEZZA 130cm • HEIGHT (51")

Codice Code	Larghezza cm Width (inches)
RB04-D03N	170 (67")
RB04-D04N	185 (73")
RB04-D06N	200 (79")
RB04-D07N	215 (85")
RB04-D08N	230 (91")
RB04-D09N	245 (96")

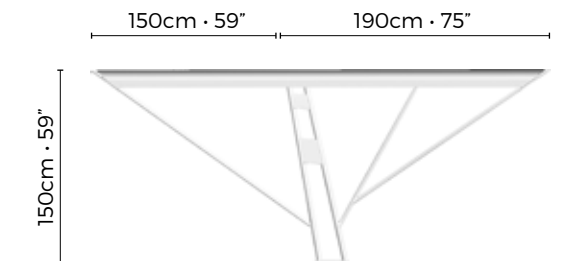

ALTEZZA 150cm • HEIGHT (59")

Codice Code	Larghezza cm Width (inches)
RB04-F01N	170 (67")
RB04-F02N	185 (73")
RB04-F03N	200 (79")
RB04-F04N	215 (85")
RB04-F05N	230 (91")
RB04-F06N	245 (96")

OPTIONAL

- LUCI PER ROLL BAR E T-TOP
ROLL BARS AND T-TOP LIGHTS Pag. 114
- TELI DI PROLUNGA
EXTENSION CANVASES Pag. 118
- CERNIERE
ZIPPERS Pag. 122
- RACING
RACING Pag. 126
- CONTROPIASTRE E POMELLI
COUNTERPLATES AND KNOBS Pag. 112
- CUSTODIA PER ROLL BAR
STORAGE BAG FOR ROLL BAR Pag. 113

INFO • INFO



Peso medio
Kg 35
Medium weight
Kg 35



Velocità consigliata
Max 30 Nodi
Recommended speed
Max 30 Knots



Nota I codici in tabella comprendono roll bar, tendalino anteriore e tendalino posteriore • **Note** Codes include roll bar, front and rear Bimini Top

FRONT SUPERIOR



1
Roll bar
con sistema ribaltabile, doppio tubo
Ø40mm in acciaio inox lucido 316L
Roll bar
with folding system, Ø40mm double
tube in 316L polished stainless steel



2
Telaio telescopico
Ø25/22 mm in acciaio inox lucido 316L
a due archi anteriori
Telescopic frame
Ø25/22 mm 316L polished stainless
steel with two front arches



3
Attacchi e viteria
Acciaio inox 316
Joints and screws
in 316 stainless steel



4
Telo
Tessuto 100% acrilico resinato,
bordo in tinta
Canvas
100% resin-coated acrylic fabric,
matching bordering tape

ACCESSORI DI SERIE • STANDARD ACCESSORIES

Applicazione della custodia sul tendalino
Storage bag application on the Bimini



Custodia
N°1 Sacca di custodia con cerniera
Storage bag
N°1 Zippered storage bag



Tenditori a nastro
N°1 Coppia di tenditori a nastro
Straps
N°1 Pair of straps

DIMENSIONI • DIMENSIONS

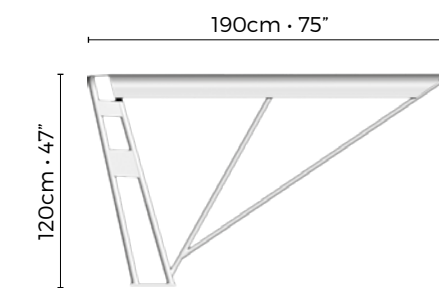

ALTEZZA 120cm • HEIGHT (47")	
Codice Code	Larghezza cm Width (iCches)
RB05-C03C	170 (67")
RB05-C04C	185 (73")
RB05-C06C	200 (79")
RB05-C07C	215 (85")
RB05-C08C	230 (91")
RB05-C09C	245 (96")

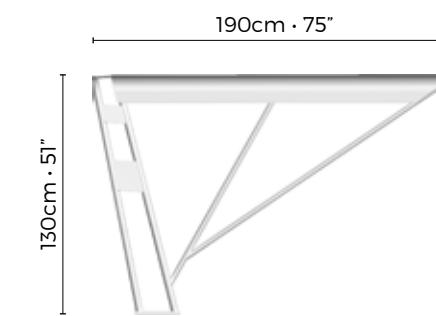

ALTEZZA 130cm • HEIGHT (51")	
Codice Code	Larghezza cm Width (iCches)
RB05-D03C	170 (67")
RB05-D04C	185 (73")
RB05-D06C	200 (79")
RB05-D07C	215 (85")
RB05-D08C	230 (91")
RB05-D09C	245 (96")

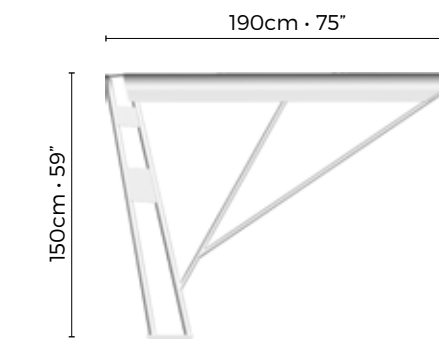

ALTEZZA 150cm • HEIGHT (59")	
Codice Code	Larghezza cm Width (iCches)
RB05-F01C	170 (67")
RB05-F02C	185 (73")
RB05-F03C	200 (79")
RB05-F04C	215 (85")
RB05-F05C	230 (91")
RB05-F06C	245 (96")

Nota I codici in tabella comprendono roll bar e tendalino • **Note** Codes include rollbar and Bimini Top

OPTIONAL

LUCI PER ROLL BAR E T-TOP
ROLL BARS AND T-TOP LIGHTS Pag. 114

TELI DI PROLUNGA
EXTENSION CANVASES Pag. 118

CERNIERE
ZIPPERS Pag. 122

RACING
RACING Pag. 126

CONTROPIASTRE E POMELLI
COUNTERPLATES AND KNOBS Pag. 112

CUSTODIA PER ROLL BAR
STORAGE BAG FOR ROLL BAR Pag. 113

INFO • INFO

KG
Peso medio
Kg 30
Medium weight
Kg 30

Velocità consigliata
Max 30 Nodi
Recommended speed
Max 30 Knots



EXCELLENT



1
Roll bar
con sistema ribaltabile, doppio tubo Ø40mm in acciaio inox lucido 316L
Roll bar
with folding system, Ø40mm double tube in 316L polished stainless steel

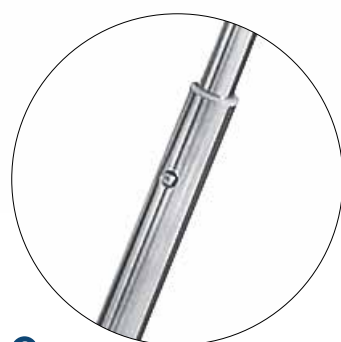

2
Telaio telescopico
Ø25/22 mm in acciaio inox lucido 316L a due archi anteriori
Telescopic frame
Ø25/22 mm 316L polished stainless steel with two front arches

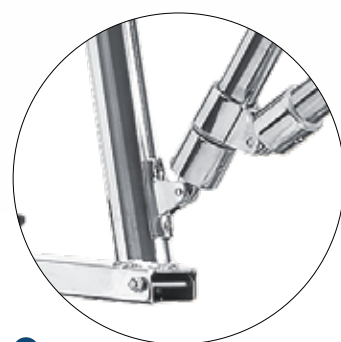

3
Attacchi e viteria
Acciaio inox 316
Joints and screws
in 316 stainless steel



4
Telo
Tessuto 100% acrilico resinato, bordo in tinta
Canvas
100% resin-coated acrylic fabric, matching bordering tape



ACCESSORI DI SERIE • STANDARD ACCESSORIES

Applicazione della custodia sul tendalino
Storage bag application on the Bimini



Custodia
N°1 Sacca di custodia con cerniera
Storage bag
N°1 Zippered storage bag



Tenditori a nastro
N°1 Coppia di tenditori a nastro
Straps
N°1 Pair of straps

DIMENSIONI • DIMENSIONS

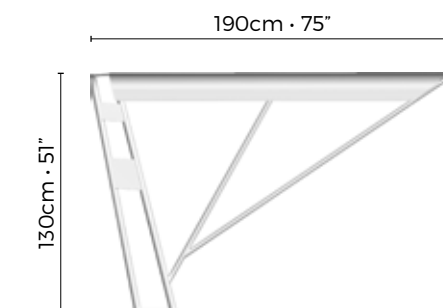

ALTEZZA 130cm • HEIGHT (51")

Codice Code	Larghezza cm Width (inches)
RB06-D01C	145 (57")
RB06-D02C	155 (61")
RB06-D03C	170 (67")
RB06-D05C	190 (75")

Nota | codici in tabella comprendono roll bar e tendalino
Note Codes include rollbar and Bimini Top

OPTIONAL

- LUCI PER ROLL BAR E T-TOP _____ Pag. 114
ROLL BARS AND T-TOP LIGHTS
- TELI DI PROLUNGA _____ Pag. 118
EXTENSION CANVASES
- CERNIERE _____ Pag. 122
ZIPPERS
- RACING _____ Pag. 126
RACING
- CONTROPIASTRE E POMELLI _____ Pag. 112
COUNTERPLATES AND KNOBS
- CUSTODIA PER ROLL BAR _____ Pag. 113
STORAGE BAG FOR ROLL BAR

INFO • INFO

KG Peso medio
Kg 30
Medium weight
Kg 30

Velocità consigliata
Max 30 Nodi
Recommended speed
Max 30 Knots



UNIVERSAL



1
Telaio telescopico
Ø25/20 mm in acciaio inox lucido 316L a un arco anteriore
Telescopic frame
Ø 25/20 mm 316L polished stainless steel with one front arch



2
Attacchi e viteria
Acciaio inox 316
Joints and screws
in 316 stainless steel



3
Telo
Tessuto 100% poliestere resinato, bordo in tinta
Canvas
100% resin-coated polyester fabric, matching bordering tape

ACCESSORI DI SERIE • STANDARD ACCESSORIES

Applicazione della custodia sul tendalino
Storage bag application on the Bimini



Custodia
Sacca di custodia con chiusura a strappo
Storage bag
Velcro closure storage bag

Coppia di supporti a forcella concavi
con vite in acciaio inox AISI 316
Pair of stainless steel AISI 316 deck hinges
with concave base and screw



Corda
10 metri di corda
Rope
10 meters of rope



Piastrine tendicorda
N°2 Piastrine tendicorda in acciaio inox
Rope tensioner plates
N°2 Stainless steel rope tensioner plates

DIMENSIONI • DIMENSIONS

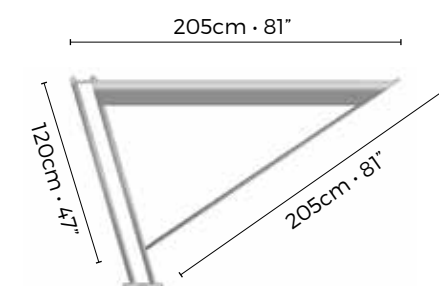

LUNGHEZZA 205cm • LENGTH (81")

Codice Code	Larghezza cm Width (inches)
RB03-C03E	170 (67")
RB03-C04E	185 (73")
RB03-C06E	200 (79")
RB03-C07E	215 (85")

Note:

- 1** Le misure disponibili si riferiscono alla larghezza di installazione in basso sul roll bar, da centro piastra a centro piastra
- 2** Possibilità di richiedere il bordo in tinta
- 3** I codici in tabella comprendono solo il tendalino

Notes:

- 1** The available sizes refer to the installation width at the bottom of the roll bar, from the centre of the plate to the centre of the plate
- 2** Matching bordering tape upon request.
- 3** The codes in the table only include the Bimini

OPTIONAL

- ROLL BAR _____ Pag. 114
ROLL BARS
- TELI DI PROLUNGA _____ Pag. 118
EXTENSION CANVASES
- CERNIERA SU BORDO _____ Pag. 122
ZIPPER ON EDGE
- RACING _____ Pag. 126
RACING

INFO • INFO



Peso medio
Kg 5
Medium weight
Kg 5



Velocità consigliata
Max 15 Nodi
Recommended speed
Max 15 Knots



JOLLY

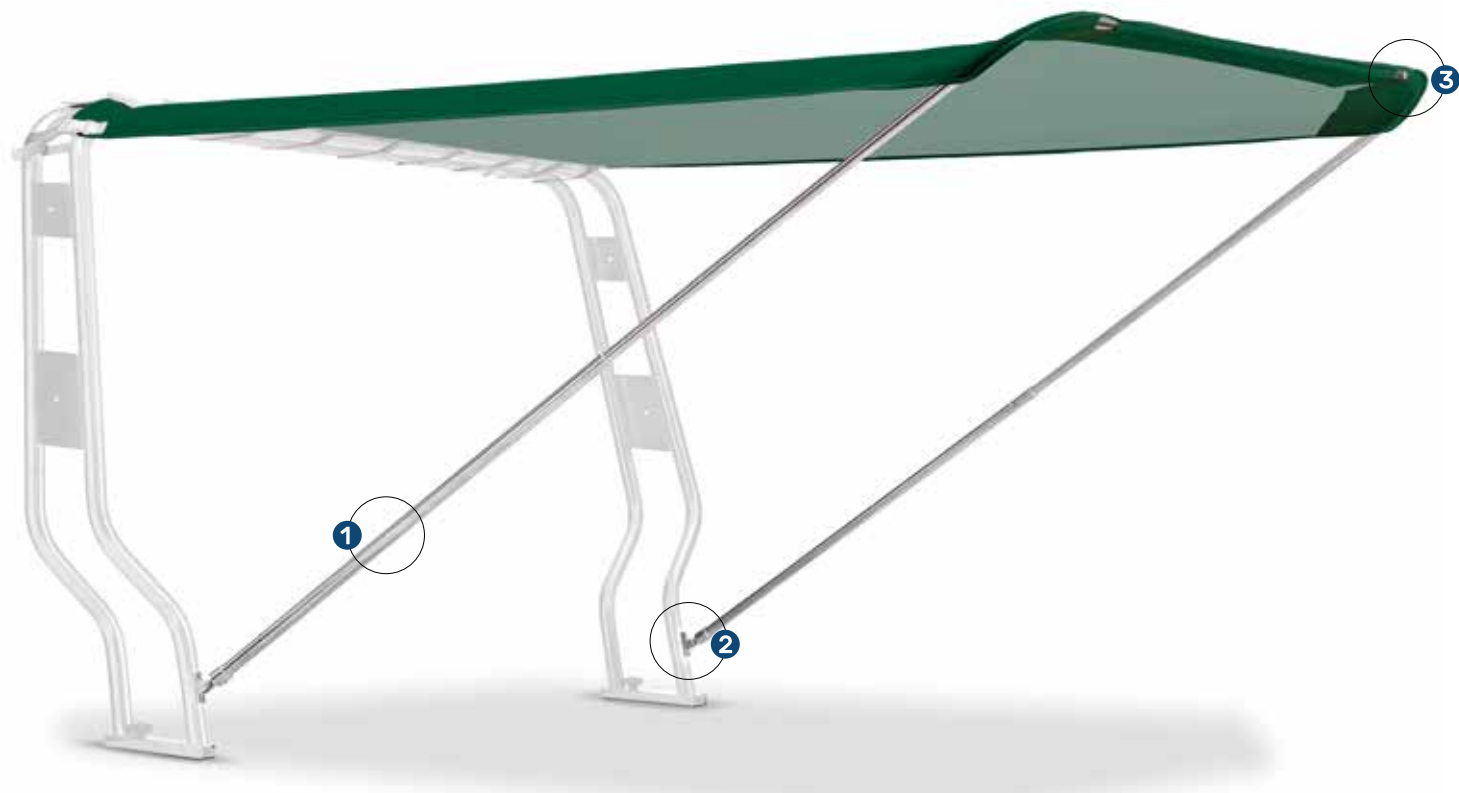

1
Telaio telescopico
Ø25/20 mm in acciaio inox lucido 316L a un arco anteriore
Telescopic frame
Ø 25/20 mm 316L polished stainless steel with one front arch



2
Attacchi e viteria
Acciaio inox 316
Joints and screws
in 316 stainless steel



3
Telo
Tessuto 100% poliestere resinato, bordo in tinta
Canvas
100% resin-coated polyester fabric, matching bordering tape

ACCESSORI DI SERIE • STANDARD ACCESSORIES

Applicazione della custodia sul tendalino
Storage bag application on the Bimini



Custodia
Sacca di custodia con chiusura a strappo
Storage bag
Velcro closure storage bag

Coppia di supporti a forcella concavi
con vite in acciaio inox AISI 316
Pair of stainless steel AISI 316 deck hinges
with concave base and screw



Corda
10 metri di corda
Rope
10 meters of rope



Piastrine tendicorda
N°2 Piastrine tendicorda in acciaio inox
Rope tensioner plates
N°2 Stainless steel rope tensioner plates

DIMENSIONI • DIMENSIONS

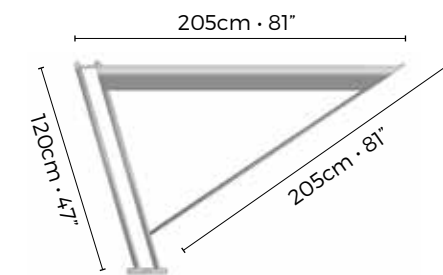

LUNGHEZZA 205cm • LENGTH (81")

Codice Code	Larghezza cm Width (inches)
RB08-C01E	145 (57)
RB08-C02E	155 (61)
RB08-C03E	170 (67)
RB08-C05E	190 (75)

Note:

- 1** Le misure disponibili si riferiscono alla larghezza di installazione in basso sul roll bar, da centro piastra a centro piastra.
- 2** Possibilità di richiedere il bordo in tinta.
- 3** I codici in tabella comprendono solo il tendalino.

Notes:

- 1** The available sizes refer to the installation width at the bottom of the roll bar, from the centre of the plate to the centre of the plate.
- 2** Matching bordering tape upon request.
- 3** The codes in the table only include the Bimini.

OPTIONAL

- ROLL BAR _____ Pag. 114
- ROLL BARS _____
- TELI DI PROLUNGA _____ Pag. 118
- EXTENSION CANVASES _____
- CERNIERA SU BORDO _____ Pag. 122
- ZIPPER ON EDGE _____
- RACING _____ Pag. 126
- RACING _____

INFO • INFO



Peso medio
Kg 5
Medium weight
Kg 5



Velocità consigliata
Max 15 Nodi
Recommended speed
Max 15 Knots



ROLL BAR

PER BARCHE E COMMONI • FOR BOATS AND INFLATABLE BOATS

ROLL BAR

PER COMMONI • FOR INFLATABLE BOATS

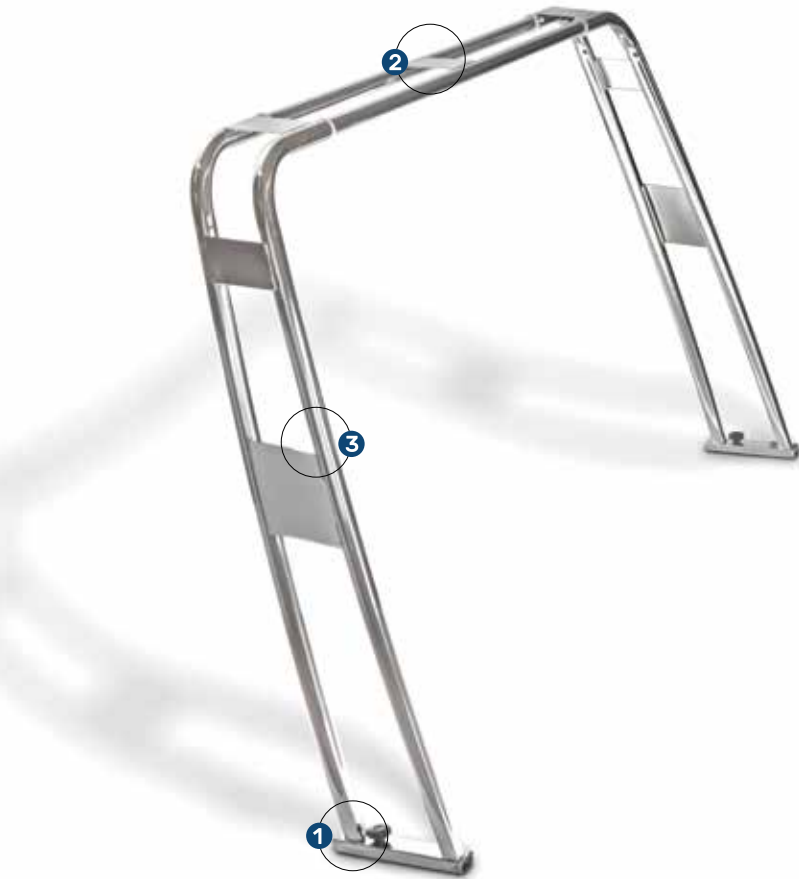

OPTIONAL

- TENDALINO • BIMINI TOP _____ Pag. 74
- LUCI PER ROLL BAR • ROLL BAR LIGHTS _____ Pag. 114
- CONTROPIASTRE E POMELLI
COUNTERPLATES AND KNOBS _____ Pag. 112

Codice • Code	Dimensioni cm • Dimensions (inches)				
	Ø Tubo • Tube	A min ÷ max	B	C	D
RB01-C02	4 (1,57")	130 ÷ 250 cm 51" ÷ 98"	120 (47")		
RB01-D02	4 (1,57")	130 ÷ 250 cm 51" ÷ 98"	130 (51")	5(2")	27(11")
RB01-F01	4 (1,57")	130 ÷ 250 cm 51" ÷ 98"	150 (59")		



1 Telaio
Doppio tubo Ø40mm in acciaio inox lucido 316L con sistema di ribaltamento per facilitare trasporto e rimessaggio
Frame
Ø40mm double tube in 316L polished stainless steel, with folding system to simplify transport and storage



2 Piastre
per fissaggio strumenti e luci di navigazione
Plates
for lights and navigation tools fixing

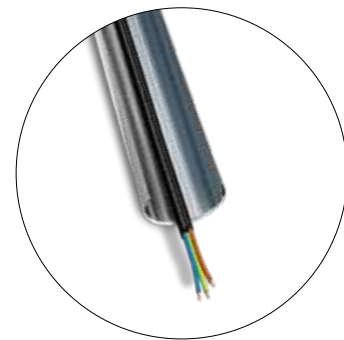

3 Passaggio cavi
Predisposizione per il passaggio cavi all'interno del telaio
Cables passage
Cables run inside the frame

KG Peso medio
Kg 20
Medium weight
Kg 20

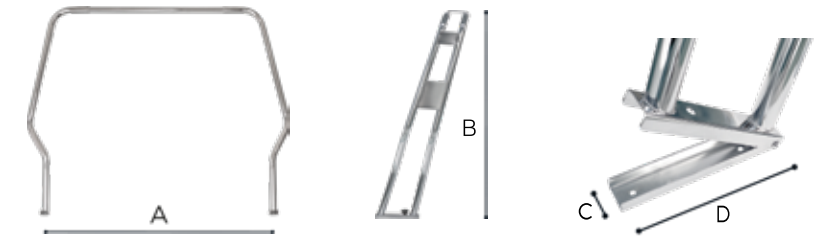

OPTIONAL

- TENDALINO • BIMINI TOP _____ Pag. 76
- LUCI PER ROLL BAR • ROLL BAR LIGHTS _____ Pag. 114
- CONTROPIASTRE E POMELLI
COUNTERPLATES AND KNOBS _____ Pag. 112

Codice • Code	Dimensioni cm • Dimensions (inches)				
	Ø Tubo • Tube	A min ÷ max	B	C	D
RB02-D01	4 (1,57")	90 ÷ 200 cm 35" ÷ 79"	130 (51")	5 (2")	27 (11")



1 Telaio
Doppio tubo Ø40mm in acciaio inox lucido 316L con sistema di ribaltamento per facilitare trasporto e rimessaggio
Frame
Ø40mm double tube in 316L polished stainless steel with folding system to simplify transport and storage



2 Piastre
per fissaggio strumenti e luci di navigazione
Plates
for lights and navigation tools fixing

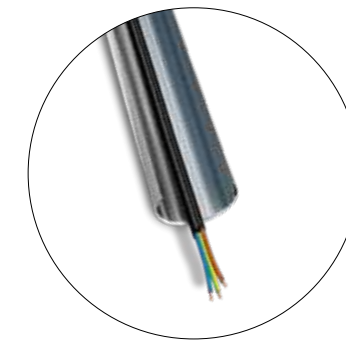

3 Passaggio cavi
Predisposizione per il passaggio cavi all'interno del telaio
Cables passage
Cables run inside the frame

KG Peso medio
Kg 20
Medium weight
Kg 20



T-TOP

I T-TOP Nettuno Marine Equipment® sono assolutamente indispensabili per tutti coloro che vogliono ripararsi dal sole, ma non vogliono rinunciare allo spazio a bordo a beneficio della **pesca**. Realizzati in tubo d'acciaio inox AISI 316L e tessuti in acrilico resinato, sono un altro elemento essenziale e distintivo di ogni imbarcazione.

*Nettuno Marine Equipment® T-TOPS are absolutely essential for all those who want to protect themselves from sun without renouncing the pleasure of **fishing**. Made of AISI 316L stainless steel tubes and acrylic fabrics, they are another essential and distinctive element of every boat.*

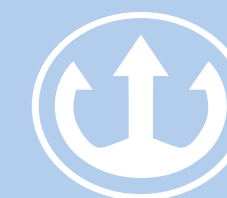

03

T-TOP

T-TOP



1
Fianchi laterali
regolabili in larghezza, tubo da
Ø35mm in acciaio inox 316L
Side panels
adjustable in width, Ø 35mm
stainless steel tube

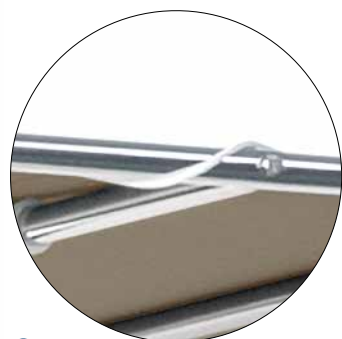

2
Top
tubo da Ø25mm acciaio inox 316L
Top
Ø25 mm tube in 316L stainless steel



3
Distanziali scorrevoli
Acciaio inox 316
Sliding spacers
in 316L stainless steel

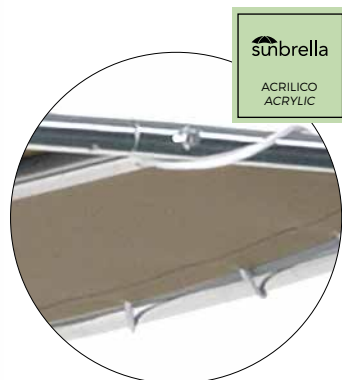

4
Telo
con occhielli inox 316.
Tessuto 100% acrilico resinato
Canvas
with 316L stainless steel rings.
100% resin-coated acrylic fabric



DESCRIZIONE

Il T-TOP è studiato per proteggere ed abbellire la postazione di guida su barche o gommoni da pesca, lasciando **libera l'area di poppa** dedicata alle manovre.

Il telaio in *acciaio inox lucido 316L* è composto da due fianchi laterali con tubo Ø35mm e una parte superiore più leggera con tubo Ø25mm per diminuire il peso complessivo della struttura.

Grazie ai *fianchi laterali regolabili* in larghezza, il T-TOP è **adattabile a qualunque tipo di console**.

Il top realizzato in *tessuto acrilico resinato* assicura un'elevata protezione dai raggi UV e resistenza agli agenti atmosferici marini.

Il telo è provvisto di anelli in acciaio inox 316 per il fissaggio al telaio superiore ed è **facilmente removibile** per la manutenzione.

DESCRIPTION

The **T-TOP** is designed to protect and embellish the driving console on fishing boats or fishing inflatable boats leaving the **stern area free**.

The 316L polished stainless steel frame is composed by two side panels with Ø 35mm tube and a lighter upper part with tube Ø 25mm to reduce the overall weight of the structure.

Thanks to the side panels adjustable in width, the T-TOP can be **adapted to any type of console**.

The top made of resin-coated acrylic fabric ensures high protection against UV rays and resistance to marine atmospheric agents.

The fabric is provided with 316 stainless steel rings for fixing to the upper frame and is **easily removable** for maintenance.

OPTIONAL

LUCI PER ROLL BAR E T-TOP _____ Pag. 114
ROLL BARS AND T-TOP LIGHTS

SPRAYHOOD PER T-TOP _____ Pag. 84
SPRAYHOOD FOR T-TOP

CHIUSURA COMPLETA PER T-TOP _____ Pag. 85
FULL CLOSURE FOR T-TOP

PORTACANNA PER T-TOP _____ Pag. 115
FISHING ROD HOLDER FOR T-TOP



DIMENSIONI • DIMENSIONS

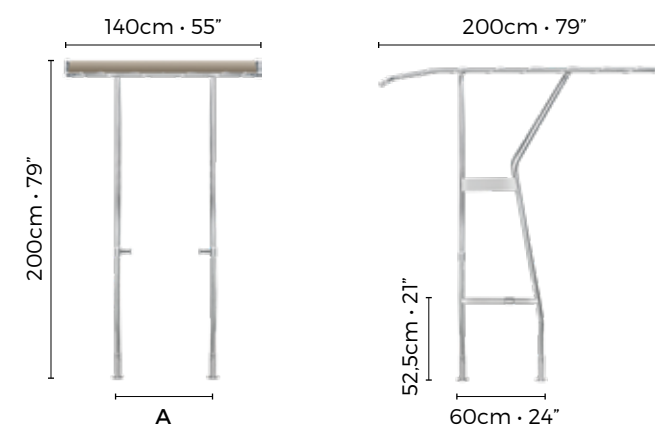

Codice Code	Dimensioni cm • Dimensions (inches)
	A
TT01	max 120 (47")

INFO • INFO



Peso medio
Kg 25
Medium weight
Kg 25



Velocità consigliata
Max 30 Nodi
Recommended speed
Max 30 Knots



SPRAYHOOD • SPRAYHOOD



1
Telo
Tessuto 100% acrilico resinato
Canvas
100% resin-coated acrylic fabric

2
Finestratura
Crystal trasparente
Window
Transparent Crystal

DESCRIZIONE

Sprayhood per T-Top in tessuto acrilico con finestrature in crystal. Questo paraspruzzi è studiato per proteggere la postazione di guida da vento e gocce d'acqua durante la navigazione.

DESCRIPTION

Sprayhood for T-Top in acrylic fabric with crystal windows. This splash guard is designed to protect the driving position from wind and water drops during the navigation.

Codice • Code

TT02



CHIUSURA COMPLETA • FULL CLOSURE



1
Telo
Tessuto 100% poliestere resinato
Canvas
100% resin-coated polyester fabric

2
Finestratura
Crystal trasparente
Window
Transparent Crystal

DESCRIZIONE

Chiusura completa per T-Top in tessuto poliestere con finestrature in Crystal studiata per proteggersi da vento e gocce d'acqua durante le soste o durante la navigazione a basse velocità.

DESCRIPTION

Complete closure for T-Top in polyester fabric with Crystal windows designed to protect against wind and water drops during the stops or during the low speed navigation.

Codice • Code

TT03



COPERTURE

Proteggere dall'aggressione della salsedine e dalle intemperie i diversi componenti dell'imbarcazione è fondamentale. Le coperture Nettuno Marine Equipment® in poliestere resinato o acrilico resinato, sono **indispensabili per proteggere la consolle, il sedile, il motore, la randa, il timone, il winch** e tanti altri componenti dell'imbarcazione. Disponibili in differenti colori e personalizzabili, non solo ripareranno ma abbelliranno ulteriormente la barca.

Protect from bad weather and salt pollution the different components of the boat is fundamental.

*Nettuno Marine Equipment® covers made of polyester or resin-coated acrylic, are **essential for the protection of consoles, seats, engines, mainsails, helms, winches** and many other components of the boat. Available in various colours and customizable, they will not only repair but further embellish the boat.*

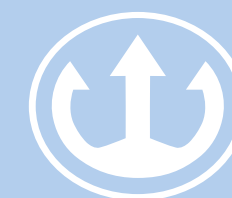

COVERS

04

COPRICONSOLE • CONSOLE COVERS

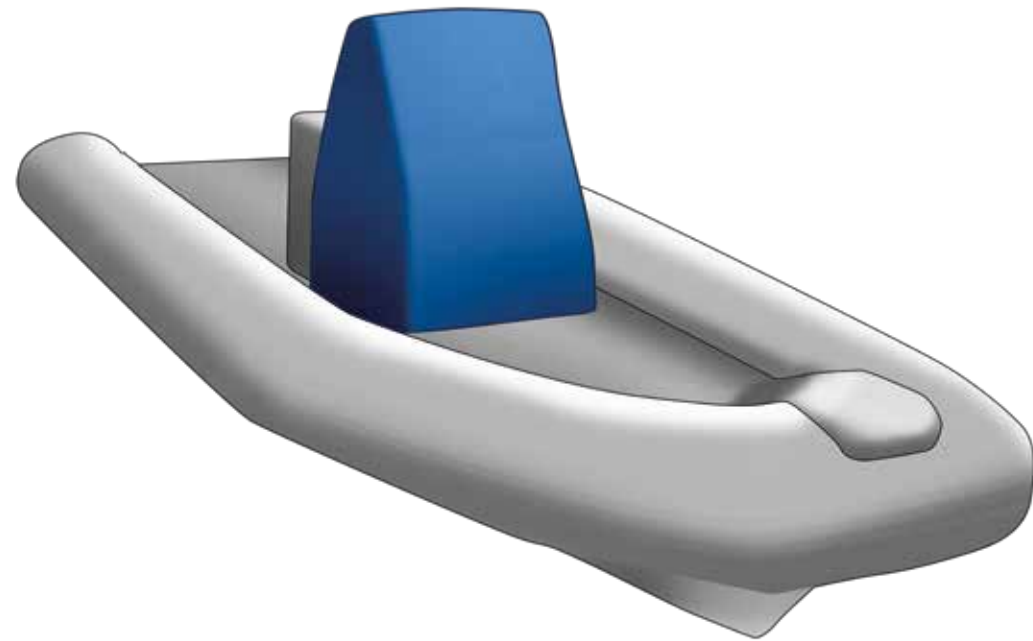

DIMENSIONI • DIMENSIONS

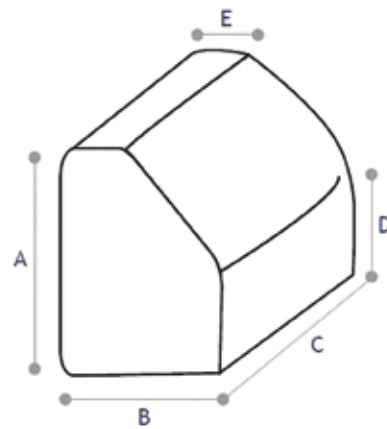

DESCRIZIONE

Bordo inferiore del telo con chiusura elastica regolabile per una migliore aderenza allo scafo.

DESCRIPTION

Lower edge of the canvas with adjustable elastic closure for a better adherence to the hull.

INFO • INFO



Codice Code	Taglia Size	Dimensioni cm • Dimensions (inches)				
		A	B	C	D	E
CO01-S	Piccolo • Small	125 (49")	65 (26")	65 (26")	60 (24")	25 (10")
CO01-M	Medio • Medium	135 (53")	70 (28")	100 (39")	65 (26")	30 (12")
CO01-L	Grande • Large	145 (57")	75 (30")	120 (47")	70 (28")	35 (14")

Nota
Possibilità di realizzazioni fuori misure standard
Note
Possibility of custom-made realizations

COPRISEDILI • SEAT COVERS

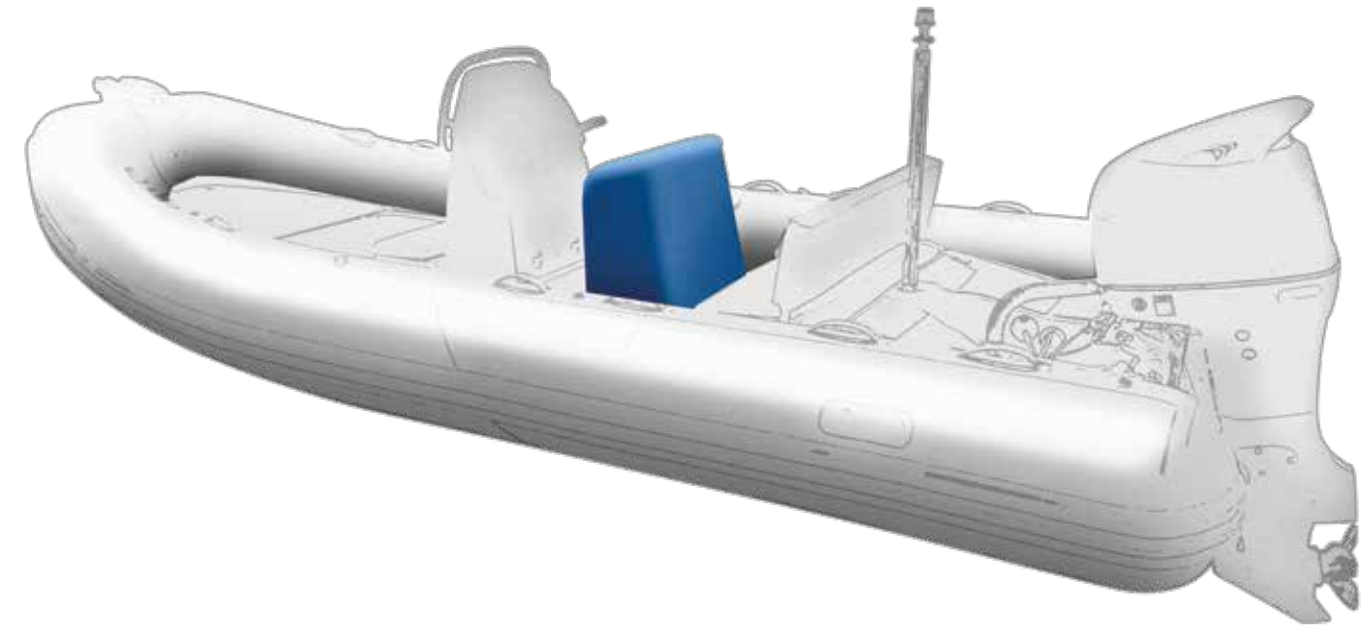

DIMENSIONI • DIMENSIONS

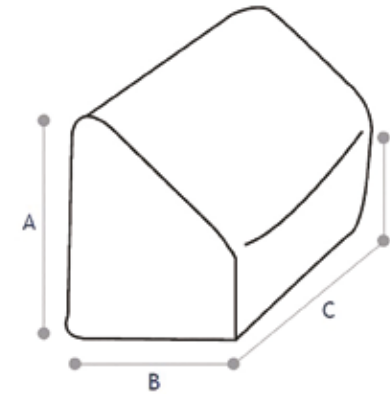

DESCRIZIONE

Bordo inferiore del telo con chiusura elastica regolabile per una migliore aderenza al sedile.

DESCRIPTION

Lower edge of the canvas with adjustable elastic closure for a better adherence to the seat.

INFO • INFO



Codice Code	Taglia Size	Dimensioni cm • Dimensions (inches)			
		A	B	C	D
CO02-S	Piccolo • Small	100 (39")	50 (20")	120 (47")	50 (20")
CO02-M	Medio • Medium	110 (43")	55 (22")	130 (51")	55 (22")
CO02-L	Grande • Large	120 (47")	60 (24")	140 (55")	60 (24")

Nota
Possibilità di realizzazioni fuori misure standard
Note
Possibility of custom-made realizations

COPRIMOTORI • ENGINE COVERS



DESCRIZIONE

Bordo inferiore con chiusura elastica regolabile per una migliore aderenza al motore.

DESCRIPTION

Lower edge of the cover with adjustable elastic closure for a better adherence to the engine.



DIMENSIONI • DIMENSIONS

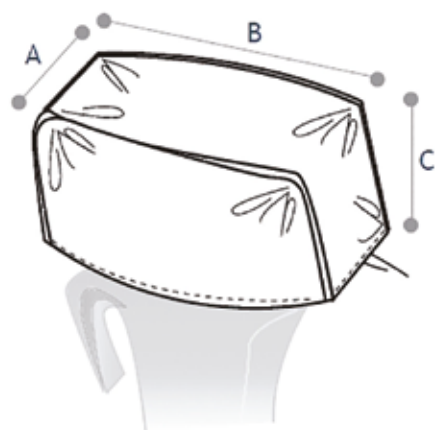

Codice Code	HP	Dimensioni cm • Dimensions (inches)		
		A	B	C
CO03-A	2.5 / 5	22 (9")	42 (17")	27 (11")
CO03-B	6 / 10	28 (11")	46 (18")	32 (13")
CO03-C	15 / 30	28 (11")	56 (22")	40 (16")
CO03-D	20 / 60	37 (15")	66 (26")	48 (19")
CO03-E	75 / 90	40 (16")	68 (27")	53 (21")
CO03-F	115 / 125	46 (18")	73 (29")	60 (24")
CO03-G	135 / 250	55 (22")	90 (35")	60 (24")

INFO • INFO



Nota
Possibilità di realizzazioni fuori misure standard
Note
Possibility of custom-made realizations

COPRITIMONI • HELM COVERS



DESCRIZIONE

Dotato di due pratiche chiusure lampo perimetrali con cerniere YKK e di una chiusura centrale posteriore con velcro che permette il passaggio del pignone.

DESCRIPTION

The helm cover is equipped with two practical perimeter closures with YKK zippers and a central back closure with Velcro which allows the passage of the pinion.



DIMENSIONI • DIMENSIONS

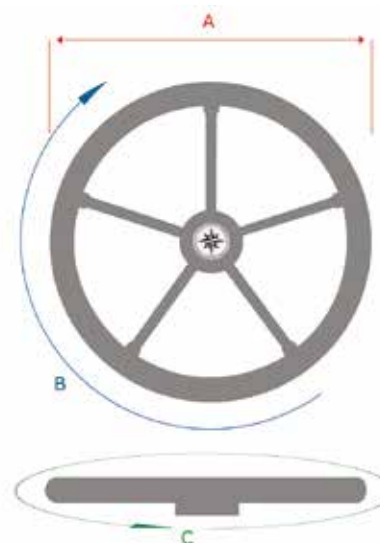

A Diametro timone • Helm diameter
B Circonferenza totale • Helm circumference
C Ingombro totale • Total sizes

Codice Code	Dimensioni cm • Dimensions (inches)
	Ø
CO04-A	80 (31")
CO04-B	90 (35")
CO04-C	100 (39")
CO04-D	110 (43")
CO04-E	120 (47")

INFO • INFO

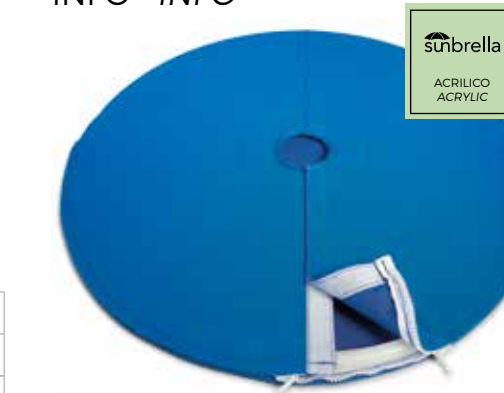

Nota
1 Al momento dell'ordine comunicare le misure A, B e C
2 Possibilità di realizzazioni fuori misure standard
Note
1 When ordering please communicate measures A, B and C
2 Possibility of custom-made realizations

COPRIWINCH • WINCH COVERS



Lato esterno • External side



Lato interno • Inner side

DIMENSIONI • DIMENSIONS



DESCRIZIONE

Utile a proteggere i verricelli da acqua salina, pioggia e polvere.

DESCRIPTION

Useful to protect winches from salt water, rain and dust.

INFO • INFO

Nota
Possibilità di realizzazioni fuori misure standard

Note
Possibility of custom-made realizations

Codice Code	Taglia Size	Dimensioni cm • Dimensions (inches)	
		A Diametro • Diameter	B Altezza • Height
CO05-S	Piccolo • Small	14 (6")	17 (7")
CO05-M	Medio • Medium	15,5 (6")	20 (8")
CO05-L	Grande • Large	17 (7")	22 (9")
CO05-X	Molto Grande • Extra Large	19,5 (8")	24 (9")



COPRI PASSO UOMO • HATCH COVERS



DESCRIZIONE

Utile a proteggere il Plexiglas ed oscurare gli interni dell'imbarcazione.

DESCRIPTION

Useful to protect Plexiglas and darken the interior of the boat.

Codice • Code

CO06



Nota

1 Prodotto su misura

2 Al momento dell'ordine indicare misure, marca e modello del passo uomo

Note

1 Custom product

2 For quotes, please indicate sizes, brand and model of the hatch

COPRIZATTERA • RESCUE BOAT COVER

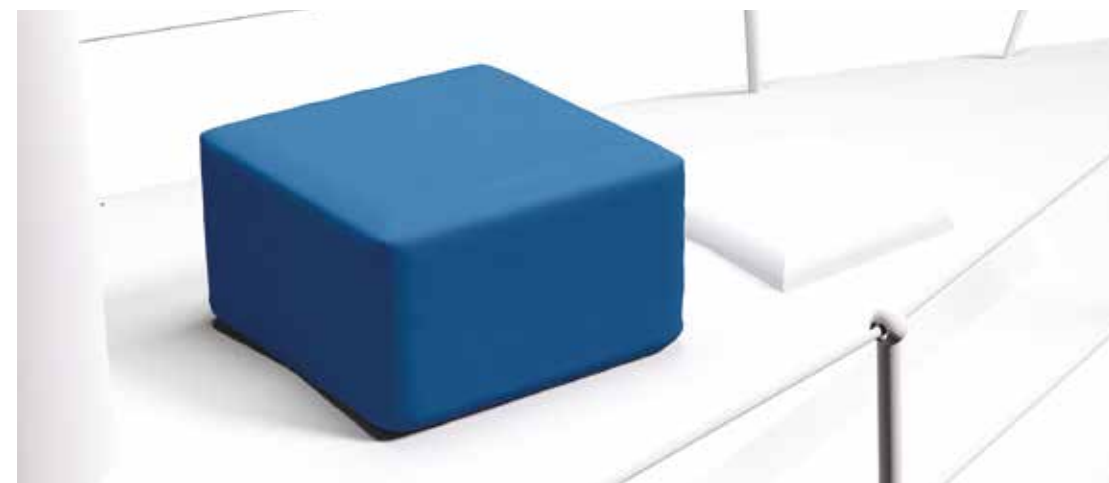

DESCRIZIONE

Bordo inferiore del telo con chiusura elastica regolabile per una migliore aderenza allo scafo.

DESCRIPTION

Lower edge of the cover with adjustable elastic closure for a better adherence to the hull.

Codice • Code

CO07



Nota

1 Prodotto su misura

2 Al momento dell'ordine indicare misure, marca e modello della zattera

Note

1 Custom product

2 For quotes, please indicate sizes, brand and model of the rescue boat

COPRIRANDA • MAINSAIL COVER

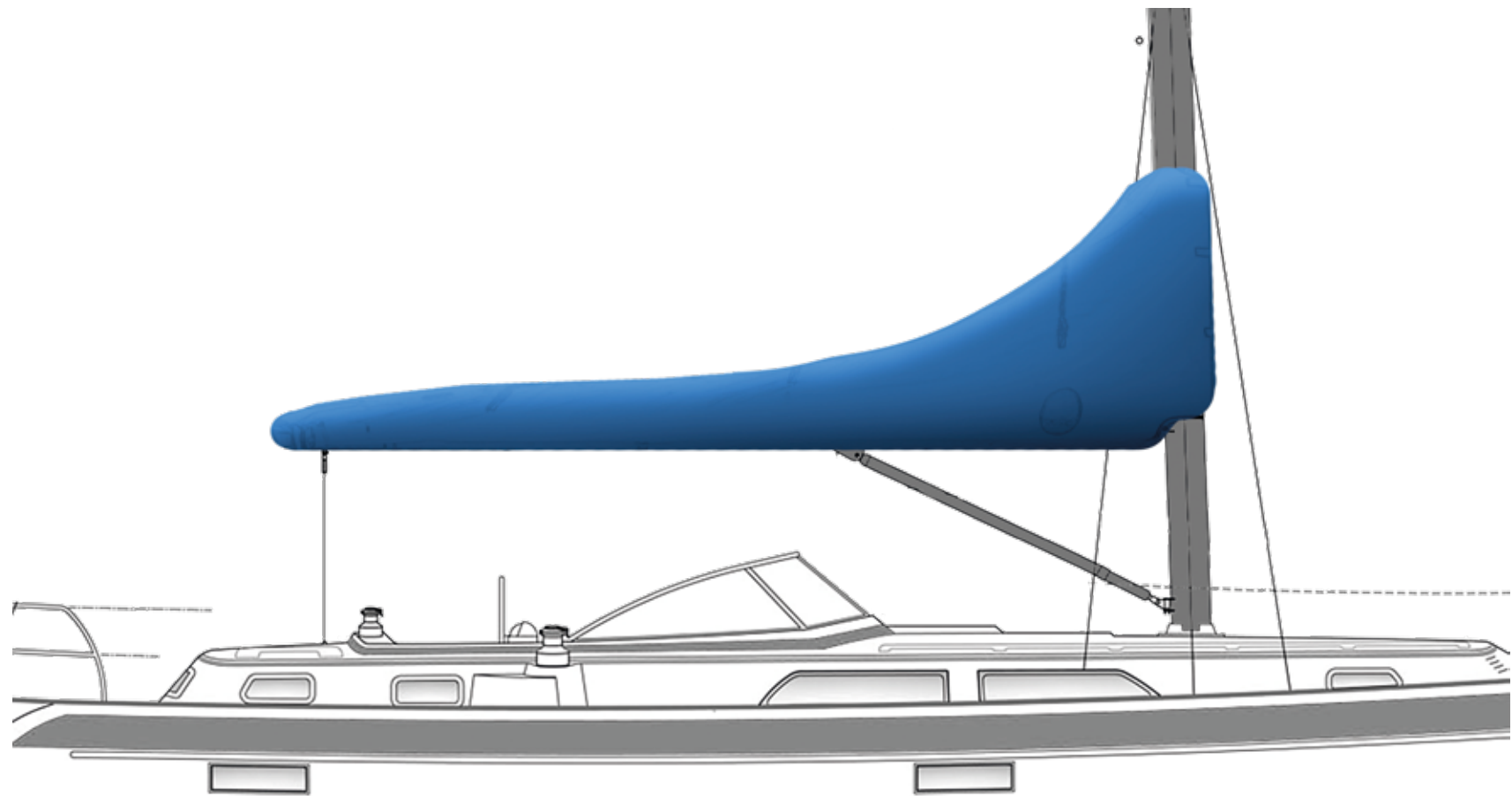

DIMENSIONI • DIMENSIONS

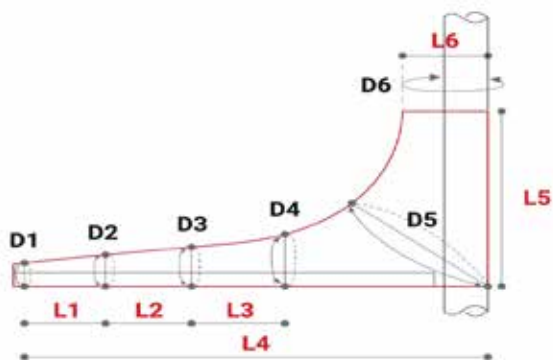

DESCRIZIONE

Elemento indispensabile per proteggere la randa da raggi UV ed intemperie quando ammainata.

DESCRIPTION

Essential element to protect the mainsail from UV rays and bad weather when lowered.

Codice Code	Dimensioni cm • Dim. (inches) Boma • Boom
CO08-A	da 0 a 3mt (from 0 to 3mt)
CO08-B	da 3 a 4mt (from 3 to 4mt)
CO08-C	da 4 a 5mt (from 4 to 5mt)
CO08-D	da 5 a 6mt (from 5 to 6mt)
CO08-E	da 6 a 7mt (from 6 to 7mt)

Note

- 1 Prodotto su misura
- 2 Al momento dell'ordine indicare le misure delle dimensioni come da schema

Notes

- 1 Custom product
- 2 Please indicate the dimensions as shown in the sketch



LAZY BAG • LAZY BAG



Nota Prodotto su misura • Note Custom product

Codice Code	Dimensioni cm • Dim. (inches) Boma • Boom
	CO09-A
CO09-B	da 3 a 4mt (from 3 to 4mt)
CO09-C	da 4 a 5mt (from 4 to 5mt)
CO09-D	da 5 a 6mt (from 5 to 6mt)
CO09-E	da 6 a 7mt (from 6 to 7mt)



FRANGIVENTO • DODGERS



DESCRIZIONE

I teli frangivento permettono di proteggersi da sguardi indiscreti e sono elemento di rifinitura sulla barca.

DESCRIPTION

Dodgers allow to protect yourself from prying eyes and are a finishing element on the boat.

Nota

- 1 Prodotto su misura
- 2 Al momento dell'ordine indicare altezza e larghezza

Nota

- 1 Custom product
- 2 The realization is made to measure. for a quote indicate height and width

Codice • Code

CO11



COPRIDRAGLIA • LIFELINES

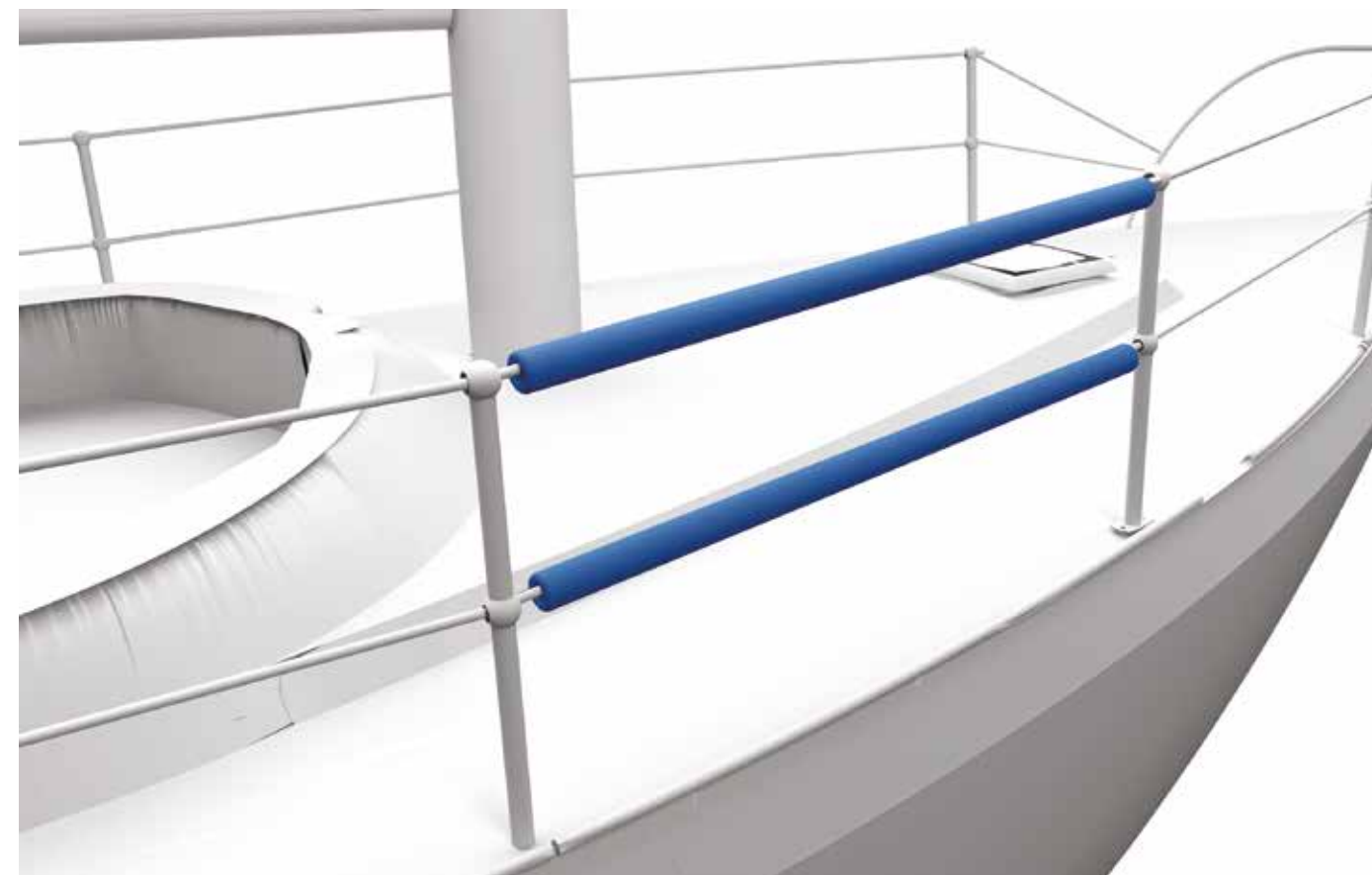

DESCRIZIONE

Copridraglia in poliuretano espanso morbido a cellula aperta Ø30mm rivestita in tessuto acrilico Sunbrella Plus.

La protezione ha una pratica chiusura a strappo e si adatta a draglie di qualsiasi diametro.

DESCRIPTION

Lifeline cover in soft open cell flexible polyurethane foam Ø30mm covered in Sunbrella Plus acrylic fabric.

The protection has a practical Velcro closure and adapts to lifelines of any diameter.

Nota

- 1 Prodotto su misura
- 2 Al momento dell'ordine indicare la lunghezza

Nota

- 1 Custom product
- 2 In the quote request indicate length

Codice • Code

CO10



ACCESSORI PER TENDALINI

Ogni tendalino richiede accessori differenti secondo le diverse **necessità di installazione**.

In acciaio inox o nylon, supporti, snodi, cappucci, ma anche puntoni, tenditori e rotaie, sono **il naturale completamento di ogni tendalino**.

*Each Bimini Top requires different accessories according to the various **installation needs**. In stainless steel or nylon, deck hinges, articulations, end caps but also struts, tensioners and rails are **the natural completion of each Bimini Top**.*

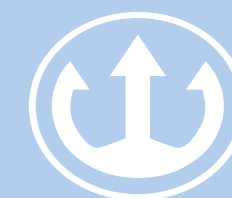

ACCESSORIES FOR BIMINI TOPS

05

ACCESSORI PER TENDALINI • ACCESSORIES FOR BIMINI TOPS

BRACCI DI RINFORZO • STRUTS



Codice Code	Materiale Material	Diametro mm Diameter (inches)	Per tendalino For Bimini Top
AT01-001	Acciaio Inox • Stainless Steel	Ø 20 (0,79")	SPORT PLUS 3 archi SPORT PLUS 4 archi
AT01-002	Acciaio Inox • Stainless Steel	Ø 22 (0,87")	ROYAL 3 archi LOOK UP 3 archi
AT01-003	Acciaio Inox • Stainless Steel	Ø 25 (0,98")	ROYAL / ROYAL XL 4 archi LOOK UP 4 archi PRESTIGE 3 archi
AT01-004	Acciaio Inox • Stainless Steel	Ø 30 (1")	EXCLUSIVE
AT01-009	Acciaio Inox • Stainless Steel	Ø 40 (1,57")	MAJESTIC

Codice Code	Materiale Material	Diametro mm Diameter (inches)	Per tendalino For Bimini Top
AT01-007	Alluminio / Acciaio Inox • Aluminium / Stainless steel	Ø 25 (0,98")	CHIC 3/4 archi



Codice Code	Materiale Material	Diametro mm Diameter (inches)	Per tendalino For Bimini Top
AT01-005	Acciaio Inox / Nylon • Stainless Steel / Nylon	Ø 20 (0,79")	SPORT 3/4 archi

Codice Code	Materiale Material	Diametro mm Diameter (inches)	Per tendalino For Bimini Top
AT01-006	Alluminio / Nylon • Aluminium / Nylon	Ø 20 (0,79")	ELEGANCE 2/3 archi

DESCRIZIONE

I bracci di rinforzo sono un **accessorio utile ad irrobustire il telaio**. Indispensabili se si vuole tenere il tendalino alto quando ripiegato, permettono di aprire e richiudere lo stesso agevolmente, avendo già un ancoraggio fisso a poppa.

Lunghezza: **1 metro**
Nota Possibilità di realizzazioni fuori misure standard.

DESCRIPTION

Struts are an **useful accessory to strengthen the frame**. They are essential to keep the Bimini Top in an high position when it is folded. They also allow to open and close it easy having already an anchoring point aft.

Length: **1 metre**
Note Possibility of custom-made realizations.

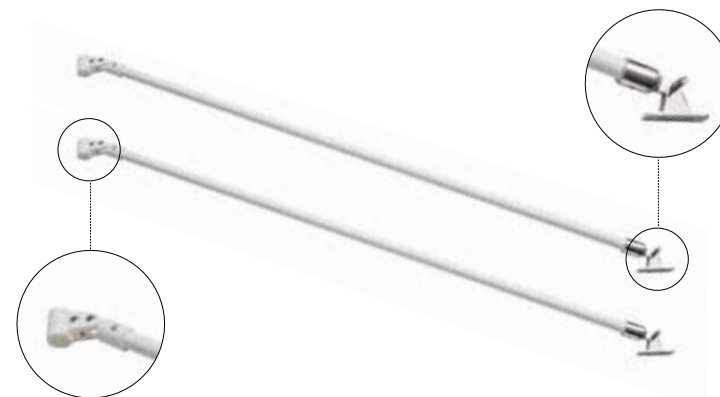

Codice Code	Materiale Material	Diametro mm Diameter (inches)	Per tendalino For Bimini Top
AT01-008	Alluminio / Acciaio Inox / Nylon • Aluminium / Stainless steel / Nylon	Ø 22 (0,87")	ELEGANCE PLUS 3/4 archi



TENDITORI • STRAPS

● NERO • BLACK



● BLU • BLUE



○ BIANCO • WHITE



● BEIGE • BEIGE



● GRIGIO • GREY



Coppia di tenditori a nastro con fibbie inox

completi di ponticelli e agganci rapidi inox
Larghezza nastro: 25mm | Lunghezza: 200cm

Pair of straps with stainless steel buckles

with jumpers and quick release hooks
Width: 25mm | Length: 200cm

Codice • Code	Colore • Colour	Dimensioni • Dimensions (inches)	
		LARGH. • WIDTH	LUNG. • LENGTH
AT02-006	● Nero • Black	25mm (0,98")	200cm (79")
AT02-004	● Blu • Blue		
AT02-003	○ Bianco • White		

Nota Possibilità di realizzazioni fuori misure standard • Note Possibility of custom-made realizations

Codice • Code	Colore • Colour	Dimensioni • Dimensions (inches)	
		LARGH. • WIDTH	LUNG. • LENGTH
AT02-002	● Beige • Beige	25mm (0,98")	200cm (79")
AT02-005	● Grigio • Grey		

CAVETTI • TURNBUCKLES

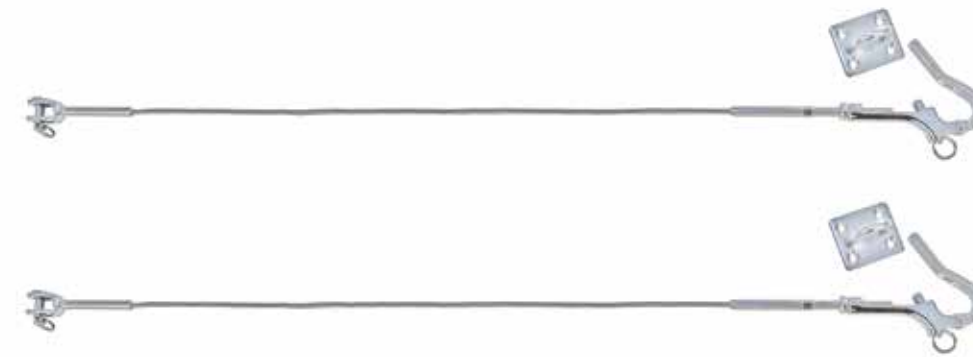

Coppia di cavetti tenditori in acciaio inox AISI 316

con moschettoni a pellicano e terminali a forcella. Completi di ponticelli in acciaio inox per il fissaggio. Lunghezza: 100cm | Cavetto: Ø 3mm

Pair of AISI 316 stainless steel turnbuckles

with pelican snap-hooks and forkend cable terminals. Equipped with stainless steel jumpers for fixing. Length: 100cm | Cable: Ø 3mm

Codice • Code	Materiale • Material	Dimensioni • Dimensions (inches)	
		LUNGHEZZA • LENGTH	Ø
AT03-001	● Inox • Steel	100cm (39")	3mm (0,1")

Nota Possibilità di realizzazioni fuori misure standard • Note Possibility of custom-made realizations

ROTAIE • RAILS



Sistema in acciaio inox AISI 316 con scorrevoli

composto da due rotaie complete di terminali e carrelli con possibilità di fermo ogni 15 mm. Dimensioni: 3 x 120cm

AISI 316 sliding stainless steel system

made of two rails equipped with end parts and rails with stop possibility each 15 mm. Dimensions: 3 x 120cm

Codice • Code	Dimensioni • Dimensions (inches)	
	LUNGHEZZA • LENGTH	SPESSORE • THICKNESS
AT03-002	120cm (47")	3cm (1")

BRACCIALE • BAND



Bracciale per aggancio tenditore in tessuto acrilico

Bracciale con anello inox utile ad agganciare il tenditore a nastro sulla maniglia del gommone. Disponibile solo nel colore grigio

Acrylic fabric band for strap hooking

Acrylic fabric band with stainless steel ring helpful to hang straps on the inflatable handle. Only available in grey colour

Codice • Code	Tessuto • Fabric
AT02-001	Acrilico resinato • Resin-coated acrylic

ACCESSORI INOX • INOX ACCESSORIES



Codice • Code
AT05-023

Supporto a forcella piatto con vite
in acciaio inox AISI 316, per installazione tendalino su superficie piana
Flat deck hinge with screw
AISI 316 stainless steel, for Bimini Top installation on flat surface



Codice • Code
AT05-022

Supporto a forcella piatto con perno sfilabile
in acciaio inox AISI 316, per installazione tendalino su superfici piane
Flat deck hinge with removable pin
AISI 316 stainless steel, for Bimini Top installation on flat surface



Codice • Code
AT05-019

Supporto con forcella snodata a 180°
in acciaio inox AISI 316, per installazione tendalino su murata o superficie piana
180° Swivelling deck hinge
AISI 316 stainless steel, for Bimini Top installation on boat side or flat surface



mm	Codice • Code
Ø 20-25	AT05-021
Ø 40	AT05-031

Supporto a forcella concavo con vite
acciaio inox AISI 316, per tubo Ø da 20mm a 25mm oppure per tubo Ø da 40mm
Concave deck hinge with screw
AISI 316 stainless steel, for tube from Ø20 to 25mm or for tube from Ø40mm

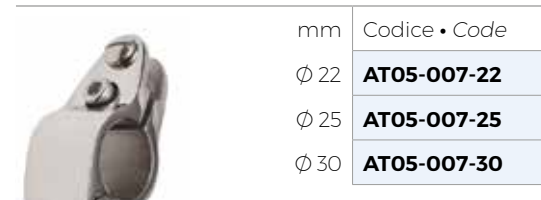

mm	Codice • Code
Ø 22	AT05-007-22
Ø 25	AT05-007-25
Ø 30	AT05-007-30

Snodo a forcella apribile con vite
acciaio inox AISI 316, per tubo Ø da 22mm a 30mm
Opening jaw slide with screw
AISI 316 stainless steel, for tube from Ø22 to 30mm

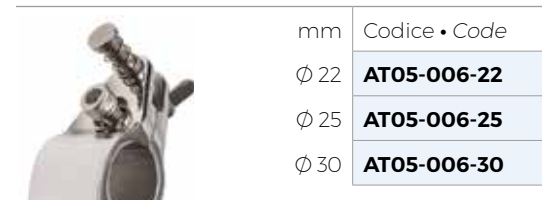

mm	Codice • Code
Ø 22	AT05-006-22
Ø 25	AT05-006-25
Ø 30	AT05-006-30

Snodo a forcella apribile con perno sfilabile
acciaio inox AISI 316, per tubo Ø da 22mm a 30mm
Opening jaw slide with pin
AISI 316 stainless steel, for tube from Ø22 to 30mm

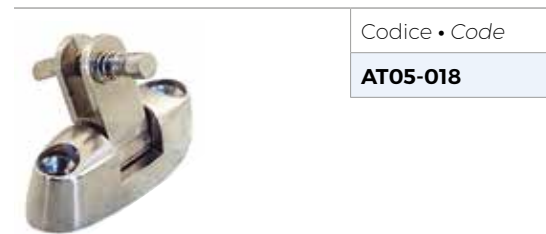

Codice • Code
AT05-018

Supporto con forcella snodata a 180°
con perno sfilabile in acciaio inox AISI 316
180° Swivelling deck hinge
with pin made of AISI 316 stainless steel



Codice • Code
AT05-017

Supporto con forcella a sgancio rapido
in acciaio inox AISI 316, per installazione tendalino su murata o superficie piana
Deck hinge with snap hooking system
AISI 316 stainless steel, for Bimini Top installation on boat side or flat surface



mm	Codice • Code
Ø 22	AT05-012-22
Ø 25	AT05-012-25

Supporto snodato inox
acciaio inox AISI 316, per tubo Ø 22mm | Ø 25mm
Articulated joint
AISI 316 stainless steel, for tube Ø 22mm | Ø 25mm



mm	Codice • Code
Ø 35	AT05-025

Snodo a forcella apribile
in acciaio inox AISI 316 Ø35mm
Opening jaw slide
in stainless steel Ø 35mm



mm	Codice • Code
Ø 22	AT05-004-22
Ø 25	AT05-004-25

Curva a 90° microfusa
acciaio inox AISI 316, per tubo Ø 22mm | Ø 25mm
Elbow 90°
AISI 316 stainless steel, for tube Ø 22mm | Ø 25mm

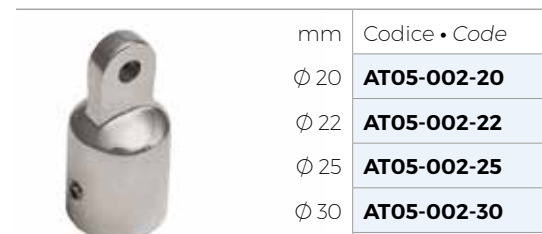

mm	Codice • Code
Ø 20	AT05-002-20
Ø 22	AT05-002-22
Ø 25	AT05-002-25
Ø 30	AT05-002-30
Ø 40	AT05-002-40

Cappuccio terminale
acciaio inox AISI 316, per tubo Ø da 20mm a 40mm
Top cap
AISI 316 stainless steel, for tube from Ø20 to 40mm



mm	Codice • Code
Ø 22	AT05-009
Ø 25	AT05-010

Supporto ad alta stabilità per tubo
acciaio inox AISI 316. Per tubo da Ø 22 e Ø 25mm
High stability deck hinge
AISI 316 stainless steel.
For tube Ø 22 and Ø 30mm



mm	Codice • Code
48 x 73	AT05-024

Supporto a parete
in acciaio inox AISI 316, per installazione tendalino sulla murata della barca
Bulkhead mount deck hinge
AISI 316 stainless steel, for Bimini Top installation on the boat side



mm	Codice • Code
Ø 20-25	AT05-020

Supporto a forcella concavo con perno sfilabile
acciaio inox AISI 316, per tubo Ø da 20mm a 25mm
Concave deck hinge with removable pin
AISI 316 stainless steel, for tube from Ø20 to 25mm

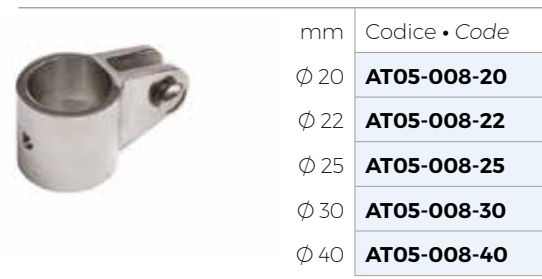

mm	Codice • Code
Ø 20	AT05-008-20
Ø 22	AT05-008-22
Ø 25	AT05-008-25
Ø 30	AT05-008-30
Ø 40	AT05-008-40

Snodo a forcella
acciaio inox AISI 316, per tubo Ø da 20mm a 40mm
Jaw slide
AISI 316 stainless steel, for tube from Ø20 to 40mm



mm	Codice • Code
Ø 22	AT05-003-22
Ø 25	AT05-003-25

Cerniera snodata
acciaio inox AISI 316 con perno di blocco, per tubo Ø 22mm | Ø 25mm
Jointed hinge
AISI 316 stainless steel with locking pin, for tube Ø 22mm | Ø 25mm

ACCESSORI INOX • INOX ACCESSORIES



mm	Codice • Code
Ø 22	AT05-013-22
Ø 25	AT05-013-25
Ø 30	AT05-013-30

T- 90° microfusa
acciaio inox AISI 316, per tubo Ø da 22mm a 30mm
Tee, 90°
AISI 316 stainless steel, for tube from Ø22 to 30mm



mm	Codice • Code
Ø 22	AT05-014-22
Ø 25	AT05-014-25

T- 90° stampata
acciaio inox AISI 316, per tubo Ø 22 | Ø 25mm
Welded Tee, 90°
AISI 316 stainless steel, for tube from Ø 22 | Ø 25mm

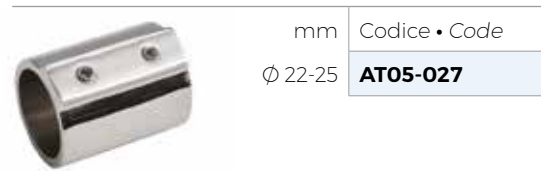

mm	Codice • Code
Ø 22-25	AT05-027

Raccordo per tubi telescopici
acciaio inox AISI 316, per tubi telescopici
Connectors for telescopic tubes
AISI 316 stainless steel, for telescopic tubes



mm	Codice • Code
Ø 25	AT05-030

Fascetta
in acciaio inox Ø 25mm con vite
Clamp
Ø 25mm stainless steel with screw



	Codice • Code
Alto • High	AT05-028
Basso • Low	AT05-029

Molla con nottolino per tubi telescopici
in acciaio inox AISI 316. Sezione nottolino: Ø8mm
AISI 316 stainless steel spring
with pawl for telescopic tubes. Pawl section: Ø8mm



	Codice • Code
Basso • Low	AT05-033

Molla in acciaio inox con nottolino basso
in acciaio inox AISI 316. Sezione nottolino: Ø6mm
AISI 316 stainless steel spring
with low pawl. Pawl section: Ø6mm



mm	Codice • Code
Ø 6	AT05-026

Perno sfilabile in acciaio inox
AISI 316. Ø 6mm con linguetta pieghevole a molla
Removable drop nose pin
AISI 316 stainless steel, Ø 6mm with spring loaded locking mechanism

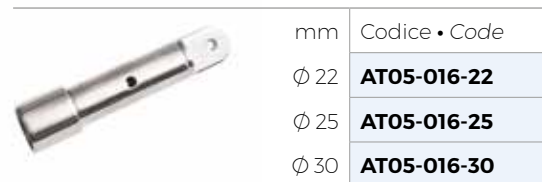

mm	Codice • Code
Ø 22	AT05-016-22
Ø 25	AT05-016-25
Ø 30	AT05-016-30

Tensionatore per bimini
per struttura tendalino in acciaio inox AISI 316, per tubo da Ø22 a 30mm
Bimini tensioner
for bimini top AISI 316 stainless steel, for tube from Ø22 to 30mm

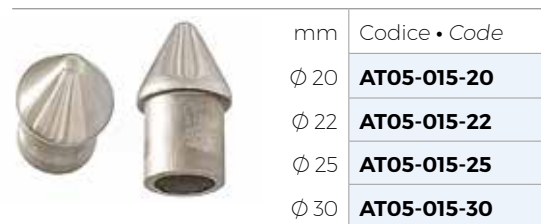

mm	Codice • Code
Ø 20	AT05-015-20
Ø 22	AT05-015-22
Ø 25	AT05-015-25
Ø 30	AT05-015-30

Tappo per tubo
in acciaio inox AISI 316, per tubo da Ø20 a 30mm
Bullet end plug for tube
AISI 316 stainless steel, for tube from Ø20 to 30mm

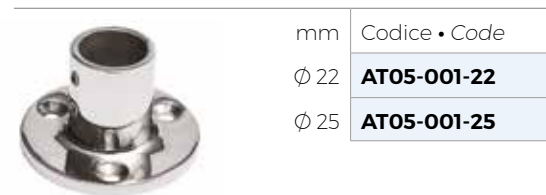

mm	Codice • Code
Ø 22	AT05-001-22
Ø 25	AT05-001-25

Base tonda per tubo
in acciaio inox AISI 316, per tubo da Ø22 | 25mm
Round tube base
AISI 316 stainless steel, for tube Ø22 | 25mm



mm	Codice • Code
Ø 22	AT05-005-22
Ø 25	AT05-005-25

Giunzione per tubo
acciaio inox AISI 316, diametro Ø 22mm | Ø 25mm
Tube connection
AISI 316 stainless steel, diameter Ø 22mm | Ø 25mm



mm	Codice • Code
Ø 25	AT05-032

Cappuccio terminale a forcella
in acciaio inox 316 Ø 25mm
Fork end cap
fork in Ø 25mm stainless steel

ATTACCHI GOMMONE DECK HINGES FOR INFLATABLE BOATS



Codice • Code
AT04-001

Basetta in EPDM con forcella inox
acciaio inox AISI 316, per installazione tendalino su gommone
EPDM support with steel fork
AISI 316 stainless steel, for installation on inflatable boats



Colore • Colour	Codice • Code
●	AT04-002
●	AT04-003

Supporto in EPDM
per installazione tendalino su gommone. Progettato per essere incollato sui tubolari dei gommone
EPDM Support
for Bimini Top installation on inflatable boats. Designed to be glued on inflatables tubulars



ACCESSORI PER TENDALINI • ACCESSORIES FOR BIMINI TOPS

ACCESSORI NYLON • NYLON ACCESSORIES



Colore • Colour	Codice • Code
○	AT06-013
●	AT06-014

Supporto a forcella piatto con vite

in nylon con vite, per installazione tendalino su superficie piana. Interasse fori: 4cm

Flat deck hinge with screw

Nylon, for Bimini Top installation on flat surface. Holes centre distance: 4cm



Colore • Colour	Codice • Code
○	AT06-015
●	AT06-016

Supporto a parete

in nylon, per installazione tendalino su murata. Interasse fori: 4cm

Side Mount Deck Hinge

Nylon, for Bimini Top installation on boat side. Holes centre distance: 4cm



Colore • Colour	Codice • Code
○	AT06-003
●	AT06-004

Boccola

in nylon, per installazione tendalino a scalmiera

Rowlock attachment

Nylon, for Bimini Top installation on rowlock



mm • Colore • Colour	Codice • Code
○ $\phi 20$	AT06-005
● $\phi 20$	AT06-006
○ $\phi 22$	AT06-017

Cappuccio terminale

in nylon, per tendalino con tubo $\phi 20/22$ mm

End cap

Nylon, for Bimini Top end cap $\phi 20/22$ mm tube

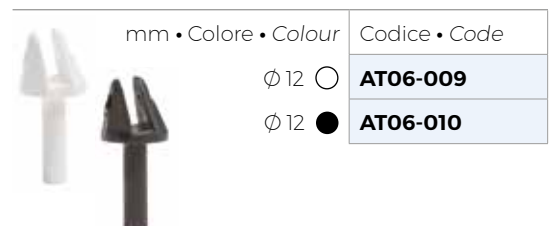

mm • Colore • Colour	Codice • Code
○ $\phi 12$	AT06-009
● $\phi 12$	AT06-010

Piedino per boccola

in nylon

Rowlock attachment pin

Nylon



mm • Colore • Colour	Codice • Code
○ $\phi 25$	AT06-001
● $\phi 25$	AT06-002

Attacco per tubo

in nylon, per installazione tendalino su tubi $\phi 25$ mm

Mounting clip for tube

Nylon, for Bimini Top installation on $\phi 25$ mm, tubes



mm • Colore • Colour	Codice • Code
○ $\phi 20$	AT06-011
● $\phi 20$	AT06-012

Snodo

in nylon, per tendalino con tubo $\phi 20$ mm

Articulated joint

Nylon, for Bimini Top with $\phi 20$ mm tube



mm • Colore • Colour	Codice • Code
○ $\phi 20$	AT06-007
● $\phi 20$	AT06-008
○ $\phi 22$	AT06-018

Giunto

in nylon, per tendalino con tubo $\phi 20/22$ mm

Jaw slide

Nylon, for Bimini Top with $\phi 20/22$ mm tube

PALI IN CARBONIO • CARBON POLE



H cm	Codice • Code
149	AT08-001-A
199	AT08-001-B

Palo in carbonio per tendalino $\phi 38$ mm Carbon pole for Bimini Top $\phi 38$ mm

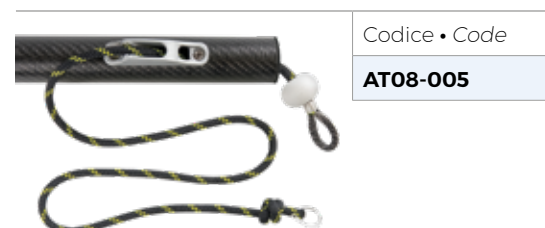

Codice • Code
AT08-005

Cima MARLOW impiombata 1300mm MARLOW spliced rope 1300mm



Codice • Code
AT08-002

Kit boccole da parete Wall-mounting bushing kit



Codice • Code
AT08-003

Boccola da incasso dritta

per palo in carbonio

Straight mounting bushing

for carbon pole

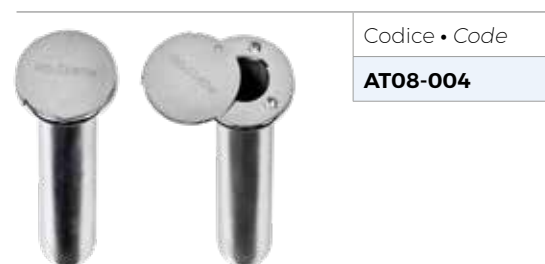

Codice • Code
AT08-004

Boccola da incasso inclinata a 6°

per palo in carbonio

Recessed-fit bushing inclined to 6°

for carbon pole



Codice • Code
AT08-006

Boccola in nylon per passerella

Flangia $\phi 80$ mm - Foro $\phi 25$ mm

Nylon bushing for gangway

Flange 80mm - Hole $\phi 25$ mm



Codice • Code
AT08-007

Boccola inox per passerella

Flangia $\phi 80$ mm - Foro $\phi 25$ mm

Stainless steel bushing for gangway

Flange 80mm - Hole $\phi 25$ mm



ACCESSORI PER ROLL BARS E T-TOP

Il roll bar è una struttura fissa che, oltre a sostenere il tendalino, permette l'applicazione di strumenti indispensabili in navigazione, come le luci di via. Tutti gli accessori possono essere installati facilmente a completamento di ogni imbarcazione.

A roll bar is a fixed structure that supports the Bimini Top and allows the application of indispensable navigation tools, such as navigation lights. All accessories can be easily installed to complete boat equipment.

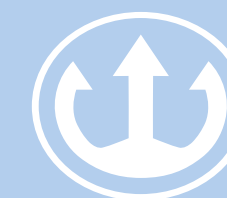

ROLL BARS AND T-TOP ACCESSORIES

CONTROPIASTRE PER ROLL BAR COUNTERPLATES FOR ROLL BAR

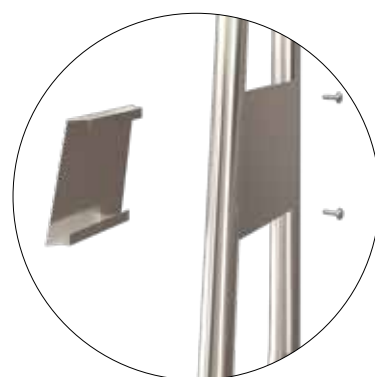
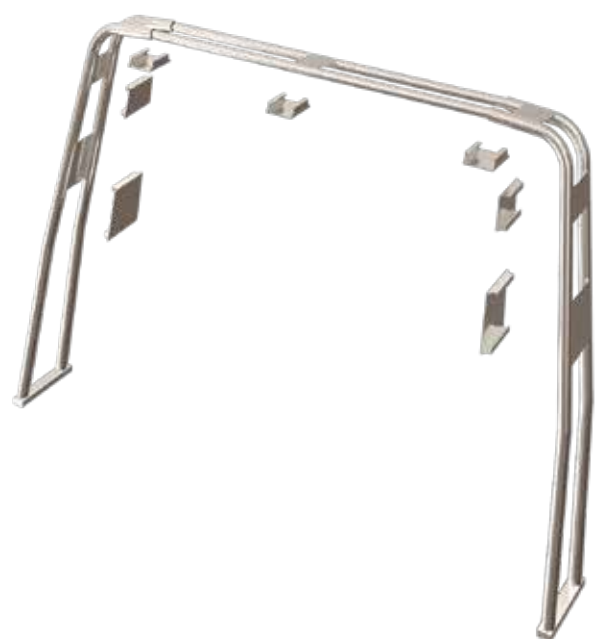

Copripiastre per roll bar

Set di 7 copripiastre in acciaio inox 316L per la rifinitura interna del roll bar.

Per modelli:
SUPERIOR / FRONT SUPERIOR / EXCELLENT / ROLL BARS PER BARCA E PER GOMMONE

Plate covers for roll bar

Set of 7 316L stainless steel plate covers for the internal finish of the roll bar.

For models:
SUPERIOR / FRONT SUPERIOR / EXCELLENT / ROLL BARS FOR BOATS AND INFLATABLE BOATS



Codice • Code	Materiale • Material
AR01-003	● Acciaio inox • Stainless Steel

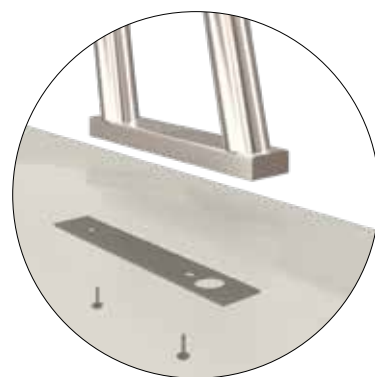

Contropiastrea inferiore per roll bar

Acciaio inox 304

Per modelli:
STRANGE XL / STRANGE SUPERIOR / FRONT SUPERIOR EXCELLENT
ROLL BARS PER BARCA E PER GOMMONE

Lower counterplate for roll bar

304 Stainless steel

For models:
STRANGE XL / STRANGE SUPERIOR / FRONT SUPERIOR EXCELLENT
ROLL BARS FOR BOATS AND INFLATABLE BOATS



Codice • Code	Materiale • Material
AR01-002	● Acciaio inox • Stainless Steel

SACCA DI CUSTODIA PER ROLL BAR STORAGE BAG FOR ROLL BAR



sunbrella
ACRILICO
ACRYLIC

MEHLER
TEKNOLOGIES
POLIESTERE
POLYESTER

Custodia per roll bar

Sacca di custodia in acrilico (cod. **AT07-006**) per modelli: SUPERIOR / FRONT SUPERIOR / EXCELLENT oppure poliestere (cod. **AT07-007**) per modelli: JOLLY / UNIVERSAL

Storage bag for roll bar

Acrylic (code **AT07-006**) for models: SUPERIOR / FRONT SUPERIOR / EXCELLENT or Polyester (code **AT07-007**) for models: JOLLY / UNIVERSAL



Codice • Code	Materiale • Material	Colori • Colors
AT07-006	Acrilico • Acrylic	sunbrella
AT07-007	Poliestere • Polyester	MEHLER TEKNOLOGIES



Pomelli

Confezione da 2 pomelli di ricambio per piastra roll bar

Knobs

Pack of 2 spare knobs for roll bar plate

Codice • Code
AR01-001



LUCI PER ROLL BAR E PER T-TOP ROLL BAR AND T-TOP LIGHTS



Fanale di fonda 360° plastica

Fanale di fonda 360° a LED "Evoled" in plastica bianca per scafi fino a 12 m. Omologato RINA e NMMA USA - 12 Volt

360° Plastic mooring light

RINA and NMMA USA type-tested for boats up to 12 m. ELE357413CS - 12 Volt

Codice • Code

AR02-002



Luci di via NEMO

Sinistra 112,5° e destra 112,5°

NEMO navigation lights

Left 112,5° and right 112,5°

Codice • Code

AR02-008



Fanale di fonda 360° inox

Fanale di fonda 360° a LED "Evoled" in acciaio inox AISI 316 per scafi fino a 12 m. Omologato RINA e NMMA USA - 12 Volt

360° Stainless steel mooring light

RINA and NMMA USA type-tested for boats up to 12 m. ELE357413CS - 12 Volt

Codice • Code

AR02-001



Plafoniera compatta

Luce compatta a 8 LED in acciaio inox lucidato e vetro in tecnopolimero con interruttore.

Fissaggio su tubi di Roll bars e T-Top da Ø35mm a Ø50mm.

Alimentazione 12/24 Volt - 1,3 Watt

Dimensioni: 104x35xh.15mm

Compact overhead light

Compact overhead light with switch, made of polished stainless steel, technopolymer glass and 8 LEDs. Mounting on Roll bars tubes and T-Top from 35mm a Ø50mm.

Power supply 12/24 Volt - 1.3 Watt. Dimensions: 104x35xh.15mm

Codice • Code

AR02-003

PORTACANNA PER T-TOP FISHING ROD HOLDER FOR T-TOP



Portacanna in acciaio INOX AISI 316

Tubo conico e protezione interna in Santoprene.

Morsetto rotante 360° orizzontale e verticale per tubi da Ø22 a Ø25,4mm.

Lunghezza 235 mm. Ø interno 44,4 mm

Rod holder in AISI 316 stainless steel

Tapered tube and internal Santoprene rod guard.

360° rotating clamp horizontally and vertically for tubes from Ø22 to Ø25,4mm.

Length 235mm. Internal Ø 44,4mm

Codice • Code

AR03-001

Materiale • Material

Acciaio inox • Stainless Steel

PRODUZIONI PERSONALIZZATE

Un punto di forza della produzione Nettuno Marine Equipment® è la capacità di soddisfare ogni richiesta del cliente con personalizzazioni che rendono **ogni prodotto unico**. Teli di prolunga, applicazione di cerniere e luci, stampa su tessuti, sono solo alcune delle possibilità offerte.

*A strength of Nettuno Marine Equipment® is the ability to satisfy every customer request with customizations that make **each product a unique one**. Extension canvases, zippers and lights applications, printing on fabrics are only some of the possibilities offered.*

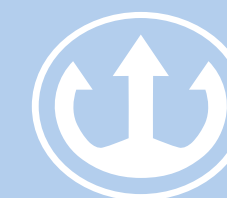

CUSTOMIZATIONS

07

TELI PROLUNGA • EXTENSION CANVASES



DESCRIZIONE

I teli di prolunga sono realizzati con lo stesso tessuto e colore del tendalino scelto. Su richiesta si possono realizzare teli di prolunga con **rete microforata** (colori disponibili nella scheda tessuti).

I teli di prolunga sono fissati al telo principale con **cerniera lampo sganciabile**.

All'altra estremità del telo di prolunga sono previsti degli **anelli in acciaio inox 316** nei quali è possibile passare la cima elastica da agganciare su un qualsiasi punto dell'imbarcazione.

È possibile ordinare anche un solo telo di prolunga laterale che potrà essere agganciato a destra o sinistra indifferentemente.

DESCRIPTION

The extension canvases are manufactured using the same fabric and colour of the Bimini Top chosen.

Upon request extension canvases can be manufactured by a **micro-perforated mesh** (available colours in the fabrics sheet).

The extension canvases are fixed to the main sheet with **detachable zipper**.

At the other end of the extension canvases there are **316 stainless steel rings** in which it is possible to pass the elastic rope to be hooked on any point of the boat.

It is possible to order just one lateral extension canvas that can be hooked either right or left.

CHIC

3 ARCHI • 3 ARCHES

Telo • Canvas	Codice • Code
Anteriore • Front A	PE01-001
Laterale • Lateral B	PE01-002
Posteriore • Rear C	PE01-003

ELEGANCE | SPORT | CHIC

4 ARCHI • 4 ARCHES

Telo • Canvas	Codice • Code
Anteriore • Front A	PE01-018
Laterale • Lateral B	PE01-019
Posteriore • Rear C	PE01-020

ROYAL | LOOK UP

3 ARCHI • 3 ARCHES

Telo • Canvas	Codice • Code
Anteriore • Front A	PE01-012
Laterale • Lateral B	PE01-013
Posteriore • Rear C	PE01-014

PRESTIGE

Telo • Canvas	Codice • Code
Anteriore • Front A	PE01-009
Laterale • Lateral B	PE01-010
Posteriore • Rear C	PE01-011

ELEGANCE | SPORT

3 ARCHI • 3 ARCHES

Telo • Canvas	Codice • Code
Anteriore • Front A	PE01-004
Laterale • Lateral B	PE01-005
Posteriore • Rear C	PE01-006

EXCLUSIVE | MAJESTIC

Telo • Canvas	Codice • Code
Anteriore • Front A	PE01-025
Laterale • Lateral B	PE01-027
Posteriore • Rear C	PE01-026

ROYAL | LOOK UP

4 ARCHI • 4 ARCHES

Telo • Canvas	Codice • Code
Anteriore • Front A	PE01-015
Laterale • Lateral B	PE01-016
Posteriore • Rear C	PE01-017

STRANGE

Telo • Canvas	Codice • Code
Anteriore • Front A	PE01-028
Laterale • Lateral B	PE01-029
Posteriore • Rear C	PE01-030

TELI PROLUNGA • EXTENSION CANVASES

PER TENDALINI • FOR BIMINI TOPS

MAJESTIC | EXCLUSIVE | LOOK UP | ROYAL | CHIC |

SPORT | ELEGANCE | PRESTIGE

PER ROLL BARS • FOR ROLL BARS

STRANGE

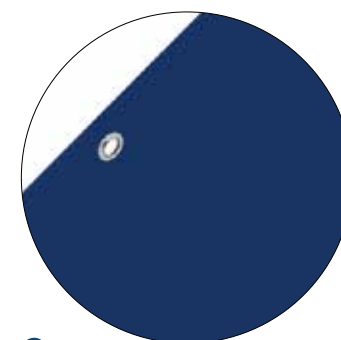

1

Telo

Stesso colore e tessuto del tendalino scelto, oppure rete microforata

Canvas

Same color and fabric as the chosen Bimini Top, or micro-perforated mesh

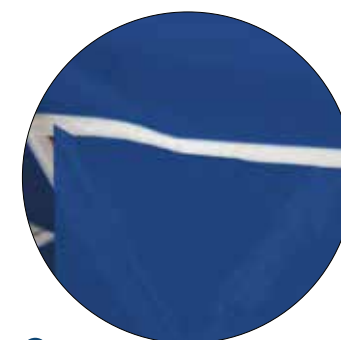

2

Cerniere lampo sganciabili

Per unire i teli

Detachable zippers

to join canvases

TELI PROLUNGA • EXTENSION CANVASES

PER ROLL BARS • FOR ROLL BARS

JOLLY | UNIVERSAL

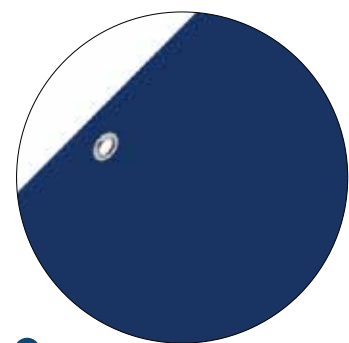

1
Telo
Stesso colore e tessuto del tendalino scelto, oppure rete microforata
Canvas
Same color and fabric as the chosen Bimini Top, or micro-perforated mesh

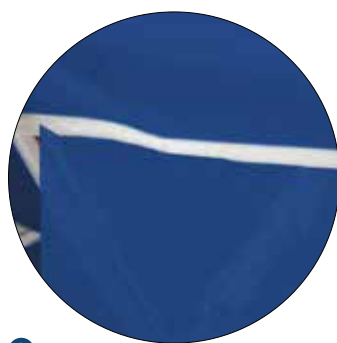

2
Cerniere lampo sganciabili
Per unire i teli
Detachable zippers
to join canvases

JOLLY | UNIVERSAL

Telo • Canvas	Codice • Code
Anteriore • Front A	PE01-007
Laterale • Lateral B	PE01-008

TELI PROLUNGA • EXTENSION CANVASES

PER ROLL BARS • FOR ROLL BARS

SUPERIOR | FRONT SUPERIOR | EXCELLENT

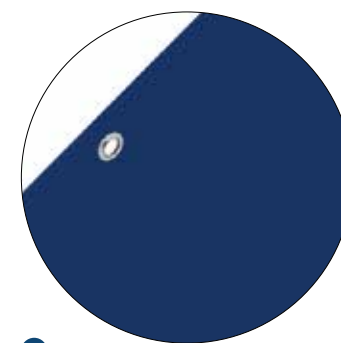

1
Telo
Stesso colore e tessuto del tendalino scelto, oppure rete microforata
Canvas
Same color and fabric as the chosen Bimini Top, or micro-perforated mesh

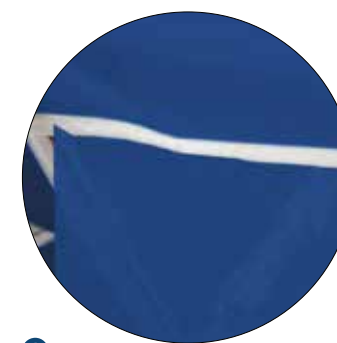

2
Cerniere lampo sganciabili
Per unire i teli
Detachable zippers
to join canvases

FRONT SUPERIOR | EXCELLENT

Telo • Canvas	Codice • Code
Anteriore • Front A	PE01-021
Laterale Anteriore • Front Lateral B	PE01-022

SUPERIOR

Telo • Canvas	Codice • Code
Anteriore • Front A	PE01-021
Laterale Anteriore • Front Lateral B	PE01-022
Laterale Posteriore • Rear Lateral C	PE01-023
Posteriore • Rear D	PE01-024

CERNIERE SU BORDO

ZIPPERS ON EDGE

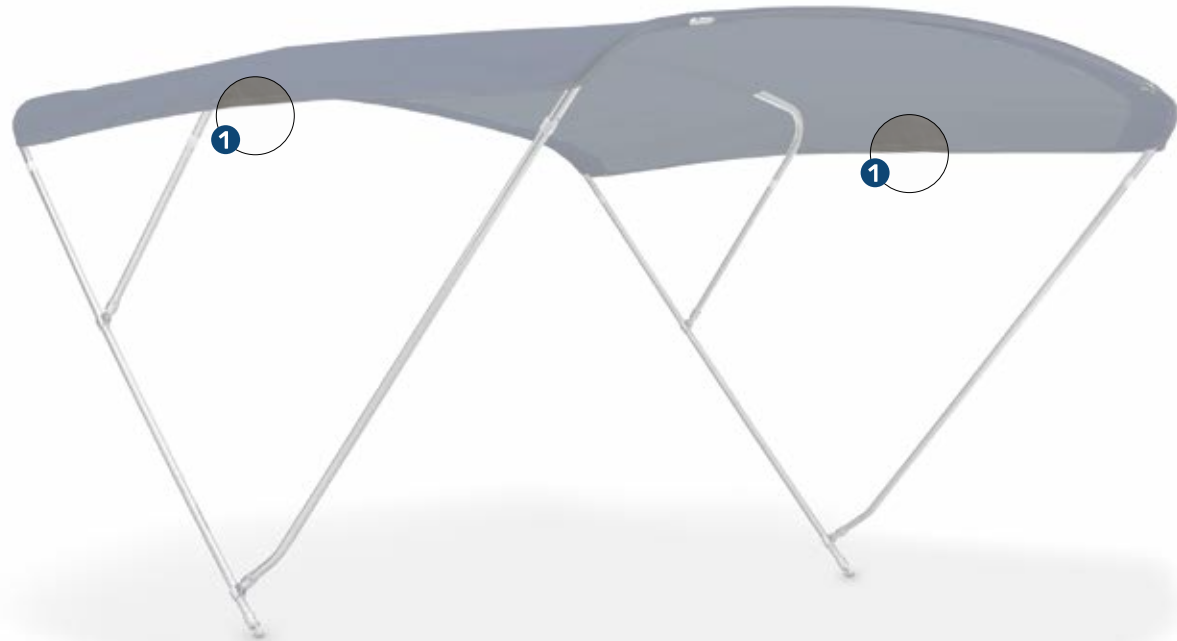

INFO • INFO

Applicazione cerniera per predisposizione del tendalino a installazione di telo di prolunga

Applicazione di cerniera lampo divisibile YKK lungo uno dei lati del telo (destra/sinistra/poppa/prua) per predisporre il tendalino all'eventuale installazione di teli di prolunga.

Nota: in caso di acquisto di teli di prolunga le cerniere saranno già comprese.

Zipper application for Bimini Top predisposition of the extension canvas installation

Application of divisible YKK zipper along one of the sides of the fabric (right / left / stern / bow) to prepare the Bimini for possible installation of extension canvases.

Note: in case of purchase of extension canvases, zipper will already be included.

Cod. • Code

PE03-001



1
Cerniere lampo sganciabili
per unire i teli di prolunga
Detachable zippers
to join canvases

CERNIERA SU FASCIA PASSAGGIO ARCO

ZIPPER ON ARCH PASSAGE BAND

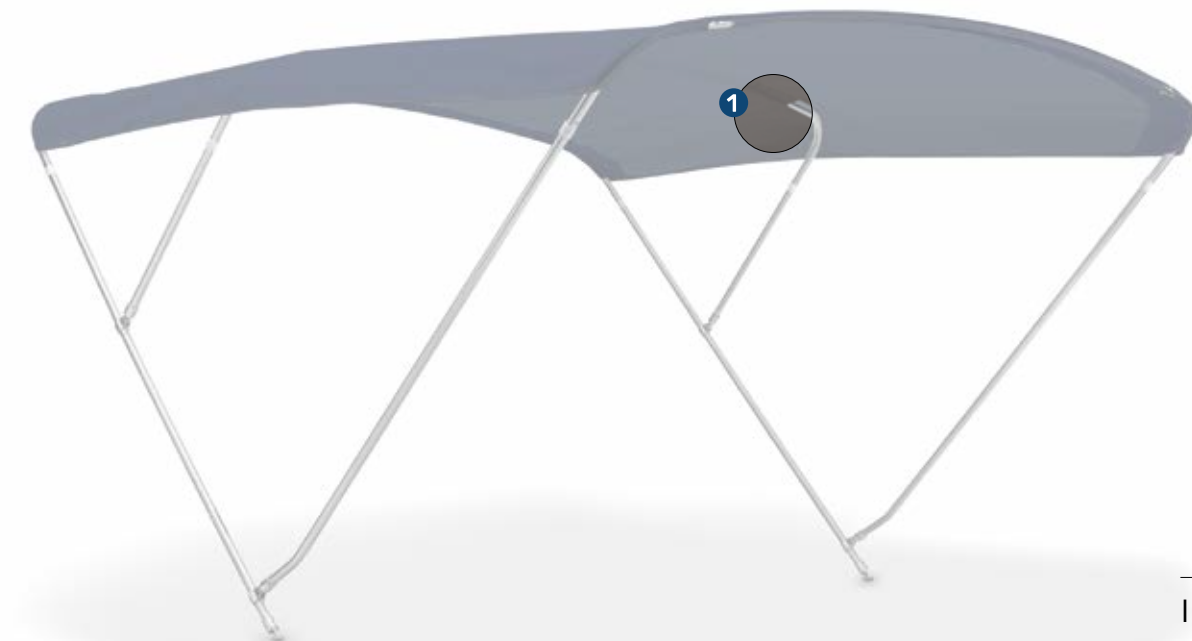

INFO • INFO

Applicazione cerniera utile a rimuovere il telo dalla struttura senza smontarla.

Applicazione di cerniera lampo divisibile YKK lungo le fasce del telo all'interno delle quali passano gli archi del telaio. Consentono di rimuovere in modo facile e veloce il telo, senza necessità di smontare la struttura.

Per modelli:
ROYAL XL / ROYAL / LOOK UP / CHIC / SPORT
3 o 4 archi

Zipper application useful for fabric removal from the structure without disassembling it.

Application of divisible YKK zipper along fabric bands inside which frame arches pass. They allow to quickly and easily remove canvas without having to disassemble the structure.

For models:
ROYAL XL / ROYAL / LOOK UP / CHIC / SPORT
3 or 4 arches

Cod. • Code

PE03-002

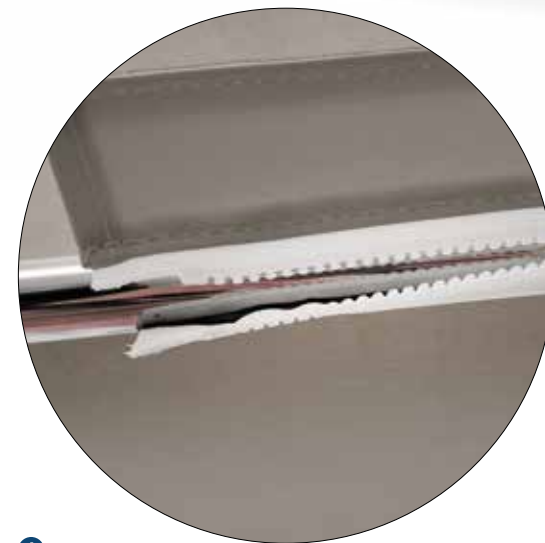

1
Cerniere sotto archi
Zipper under the arches

LED WATERPROOF



Codice • Code
PE02-002

Spina stagna in ottone cromato
per murata. 2 POLI - 10 amp.
Nickel plated brass connector
for boat side. 2 POLES - 10 amp.



Codice • Code
PE02-003

Spina stagna in policarbonato
per murata. Con contatti in ottone. 2 POLI - 8 amp.
Polycarbonate watertight connector
for the boat side. With brass contacts. 2 POLES - 8 amp.



Codice • Code
PE02-004

Cavo 10 mt + Connettore IP maschio
10 m Cable + Male IP Connector



Lunghezza • Length
cm 100 **PE02-005**
cm 150 **PE02-006**

STRIP LED waterproof luce calda
+ 1 m cavo e connettore IP
STRIP LED waterproof, warm light
+ 1 m cable and IP connector female



Applicazione LED waterproof su tendalino

Striscia led waterproof integrata su telo del tendalino con fascia di crystal.
La fascia è cucita in corrispondenza dell'arco centrale.
Nota Per strutture 4 archi scegliere due applicazioni led per i due archi centrali.

Waterproof led application on Bimini Top

Integrated waterproof led strip on Bimini Top canvas with a crystal band.
The band is sewn at the central arch.
Note For 4 arches frame, choose two LED applications for the two central arches.

Codice • Code	Lunghezza • Length
PE02-001	150cm

LUCE 360° • 360° LIGHT



Applicazione luce 360° su tendalino

Luce di fonda a 360° in acciaio inox con sorgente luminosa Led, integrata su arco posteriore del tendalino con supporto inox.
Per modelli:
EXCLUSIVE | LOOK UP | ROYAL | CHIC | PRESTIGE

360° light application on Bimini Top

360° mooring light in stainless steel with LED light source, integrated on the rear Bimini Top arch with a stainless steel support.
For models:
EXCLUSIVE | LOOK UP | ROYAL | CHIC | PRESTIGE

Codice • Code	Materiale • Material
PE04-001	● Acciaio inox • Stainless steel



TAGLIO ROLL BAR • CUT OF THE ROLL BAR



Taglio su misura della barra centrale del roll bar.
Customized cut of the central roll bar tube.

Cod. • Code
PE07-001

RACING



Made in
Italy



Personalizzazione "Racing" su tendalino

Il colore delle bande è a scelta tra i colori poliestere o acrilico

"Racing" Bimini Top customization

The colour strip can be chosen among polyester or acrylic colours.

Cod. • Code

PE05-001

STAMPA • PRINT

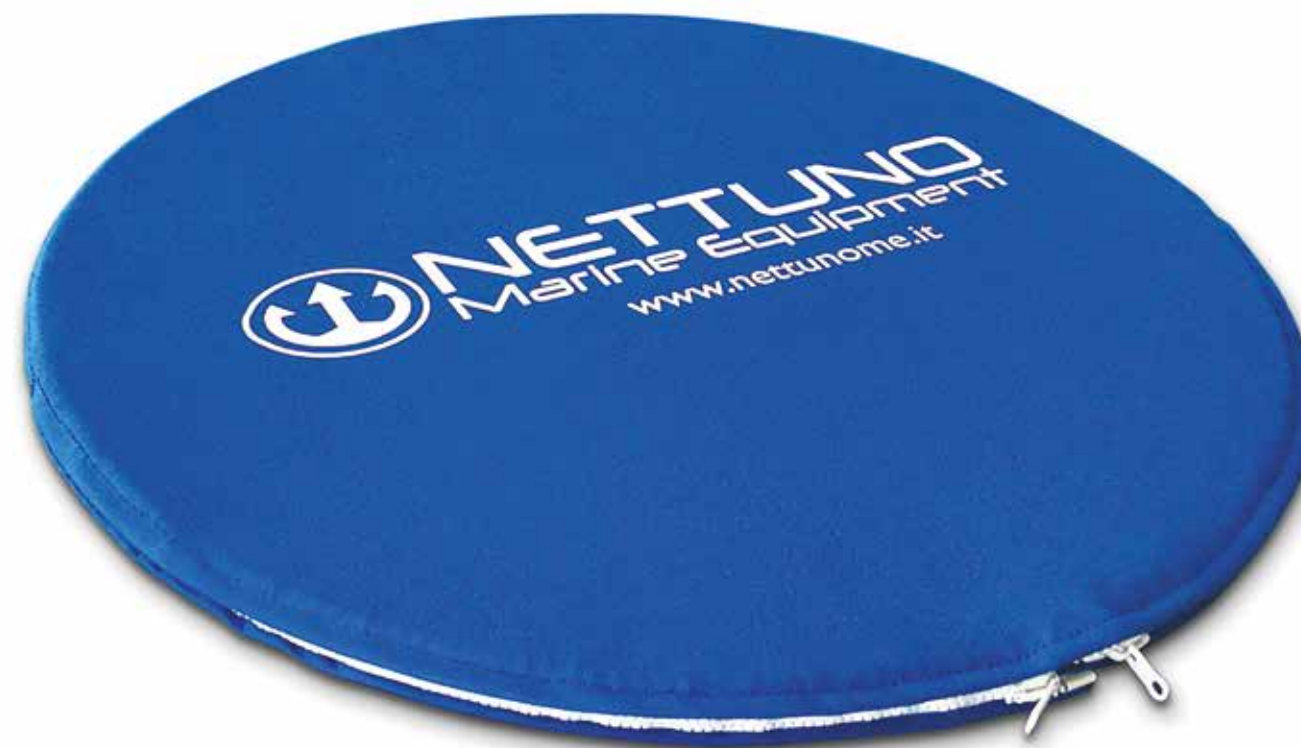

Stampa personalizzata su tessuto acrilico o PVC

Stampa personalizzata su tessuto acrilico, PVC o poliestere. Il file per la stampa con dimensioni massime H 35cm dovrà essere fornito in formato vettoriale (.ai | .pdf)

Customized printing on acrylic fabric or PVC

Customized printing on acrylic fabric, PVC or polyester. Files for print should be with maximum sizes of H 35cm and should be in vector format (.ai | .pdf)

Cod. • Code

PE06-001

TELAI PER TENDALINI E SPRAYHOODS

Grazie all'officina meccanica interna e all'ufficio tecnico, Nettuno Marine Equipment è in grado di progettare e produrre **telai personalizzati per tendalini e sprayhoods** in acciaio inox 316L o alluminio.

La maestria artigianale e i moderni macchinari CAD/CAM consentono la realizzazione di telai a raggi variabili e personalizzabili, robusti e duraturi.

*Thanks to its Mechanical Workshop and Technical Office, Nettuno Marine Equipment is able to design and produce **customized frames for Bimini Tops and Sprayhoods** in 316L stainless steel or aluminium.*

The craftsmanship and the modern CAD/CAM machines allow the realization of variable and customizable radius frames, robust and long-lasting.

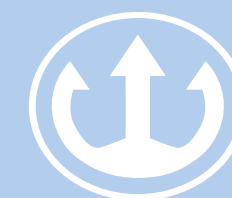

FRAMES FOR BIMINI TOPS AND SPRAYHOODS



TELAI PER TENDALINI FRAMES FOR BIMINI TOPS

4 ARCHI • 4 ARCHES

Codice • Code

TL004

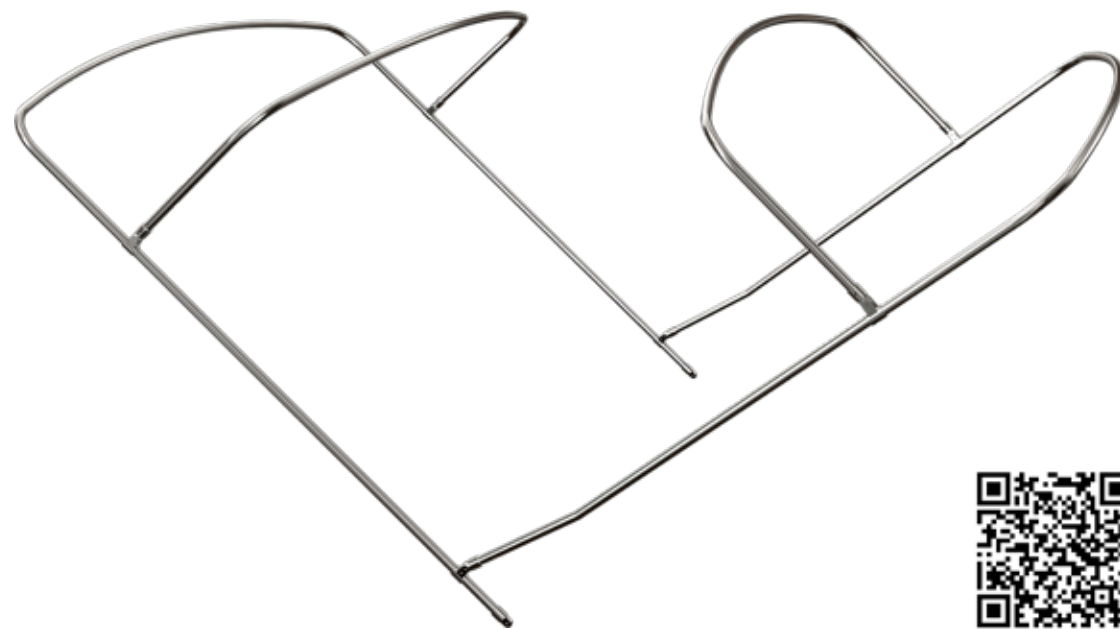

3 ARCHI • 3 ARCHES

Codice • Code

TL003



2 ARCHI • 2 ARCHES

Codice • Code

TL002



DESCRIZIONE

Telai su misura per tendalini e sprayhood in **alluminio verniciato bianco Ø20-25mm** o in **acciaio inox 316L Ø20-22-25-30-40mm**.

Particolari tecnologie CAD tridimensionali e macchinari CAM di ultimissima generazione permettono di produrre telai con curvature a raggi variabili che rispecchiano perfettamente il disegno tecnico. Ogni telaio è sottoposto ad un attento controllo qualità che ne valuta la corrispondenza con la sagomatura desiderata.

Tutti i telai possono essere prodotti in un **unico pezzo, smontabili oppure ripiegabili** per ridurre al minimo gli ingombri.

La ottima qualità dei materiali e la manifattura accurata fanno dei telai Nettuno Marine Equipment il fiore all'occhiello dell'intera produzione.

TELAI PER SPRAYHOOD FRAMES FOR SPRAYHOOD

DESCRIPTION

Tailor-made frames for Bimini Tops and sprayhoods in **white painted aluminum Ø20-25mm** or in **316L stainless steel Ø20-22-25-30-40mm**.

Particular three-dimensional CAD technologies and the latest generation of CAM machines make it possible to produce frames with variable radius curvatures that perfectly reflect the technical design. Each frame is subjected to a careful quality control that evaluates its correspondence with the desired shape.

All frames can be produced **in one piece, can be dismantled or folded** to reduce the overall dimensions to a minimum.

The excellent quality of the materials and the accurate manufacture, make the Nettuno Marine Equipment frames the flagship of the entire production.

Codice • Code

TL001

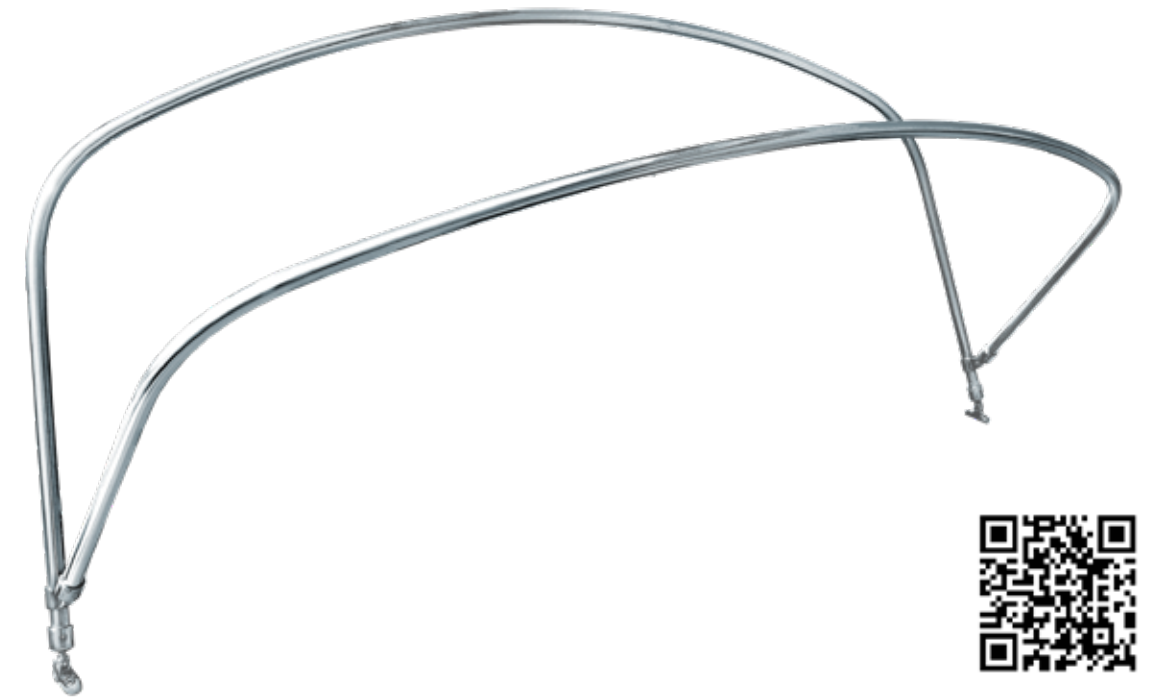

TUBI

La riuscita di ogni progetto dipende dalla materia prima con cui lo si realizza. Per questo Nettuno Marine Equipment utilizza e fornisce solo tubi in **alluminio verniciato e acciaio inox AISI 316L** di prima qualità.

The success of any project depends on the raw material by which it is manufactured. For this reason, Nettuno Marine Equipment uses and supplies only top quality painted aluminum and AISI 316L stainless steel tubes.

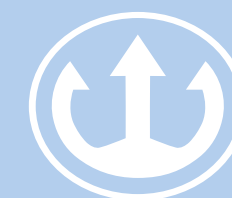

09

TUBES

TUBI ACCIAIO INOX • STAINLESS STEEL TUBES



DESCRIZIONE

I tubi proposti da Nettuno Marine Equipment sono in **acciaio inox lucido 316L, a sezione tonda con saldatura a TIG**.

Gli acciai inossidabili, grazie alla loro proprietà intrinseca di passivazione, sono leghe metalliche per loro natura resistenti alla corrosione.

L'acciaio inox AISI 316L, chiamato anche "1.4404" si caratterizza per la minima quantità di carbonio presente contenuto (<0,03%), il che con l'aggiunta di molibdeno rende questa lega **altamente resistente agli agenti corrosivi**.

L'utilizzo è consigliato sia per realizzazioni in ambienti esterni che in ambiente marino.

I tubi possono essere tagliati su misura e sono disponibili nei diametri 20/22/25/30/40mm in vari spessori.

DESCRIPTION

Tubes proposed by Nettuno Marine Equipment are made of **316L polished stainless steel, with round section with TIG welding**.

Stainless steels, due to their inherent passivation properties, are metal alloys which by their nature are resistant to corrosion.

The AISI 316L stainless steel, also called "1.4404" is characterized by the minimum amount of carbon present content (<0.03%), which with the addition of molybdenum makes this alloy **highly resistant to corrosive agents**.

Use is recommended for both outdoor and marine environments.

Tubes can be cut to size and are available in diameters 20/22/25/30/40mm in various thicknesses.



Codice Code	Dimensioni mm • Dimensions (inches)	
	Ø	SPESSORE • THICKNESS
TB01-001	20 (0,79")	1.0 (0,04")
TB01-002	22 (0,87")	1.2 (0,05")
TB01-003	25 (0,98")	1.2 (0,05")
TB01-004	25 (0,98")	1.5 (0,06")
TB01-005	30 (1,18")	1.5 (0,06")
TB01-008	40 (1,57")	1.5 (0,06")

COMPOSIZIONE CHIMICA (valori massimi) • CHEMICAL COMPOSITION (maximum values)									
LEGA • ALLOY	C	Mn	Si	Cr	Ni	P	Mo	N	
AISI 316L (1.4404)	0,03	2	1	16,5 ÷ 18,5	8 ÷ 13	0,04	2 ÷ 2,5	0,11	

TUBI ALLUMINIO • ALUMINIUM TUBES

DESCRIZIONE

I tubi in **alluminio bianco** sono composti da una lega di alluminio-magnesio-silicio e verniciati a polvere.

La verniciatura a polvere è un procedimento che riveste le superfici metalliche con un **film organico e protegge il materiale dagli agenti corrosivi**, come acqua e salsedine.

L'utilizzo è consigliato sia in ambienti esterni che in ambiente marino.

I tubi possono essere tagliati su misura e sono disponibili nei diametri 22/20/25mm.

DESCRIPTION

White aluminium tubes are composed of an aluminium-magnesium-silicon alloy and powder-coated.

Powder coating is a process that covers metal surfaces with an organic **film and protects the material from corrosive agents** such as water and salt.

Use is recommended both in outdoor and in marine environments.

Tubes can be cut to size and are available in diameters 22/20/25mm.



Codice Code	Dimensioni mm • Dimensions (inches)	
	Ø	SPESSORE • THICKNESS
TB02-001	20 (0,79")	1.5 (0,06")
TB02-002	22 (0,87")	1.5 (0,06")
TB02-003	25 (0,98")	1.5 (0,06")

COMPOSIZIONE CHIMICA (valori massimi) • CHEMICAL COMPOSITION (maximum values)										
LEGA • ALLOY	Si	Fe	Cu	Mn	Mg	Cr	Zn	Ti	Al	
EN AW-6060	0,30 - 0,60	0,10 - 0,30	0,1	0,1	0,35 - 0,60	0,05	0,15	0,1	resto • remaining	

TESSUTI NAUTICI

Un tessuto nautico di qualità è sinonimo di **protezione e lunga durata** nel tempo.

Per questo Nettuno Marine Equipment seleziona accuratamente una vasta gamma di tessuti per tendalini, sprayhood, coperture solari, coperture nautiche e cuscinerie esterne.

Gli speciali trattamenti garantiscono protezione da raggi UV e contrastano l'azione degli agenti corrosivi marini.

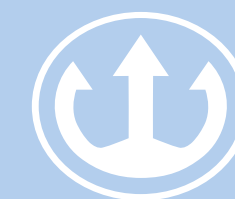

*A top quality fabric is synonymous with **protection and durability** along the time.*

Nettuno Marine Equipment carefully selects a wide range of fabrics for Bimini Tops, Sprayhoods, outdoor and marine awnings and cushions.

The special treatments guarantee protection from UV rays and counteract the action of marine corrosive agents.

MARINE FABRICS

POLIESTERE RESINATO

RESIN COATED POLYESTER

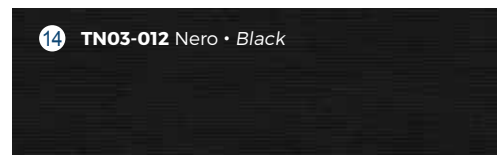
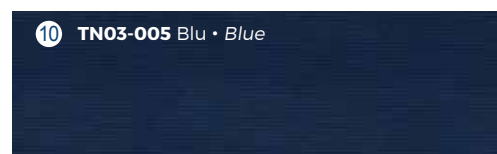
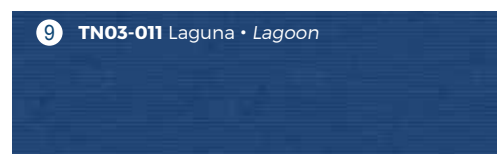
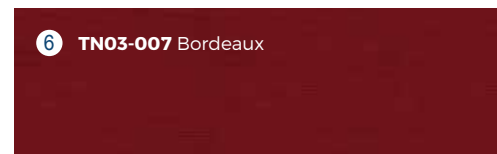
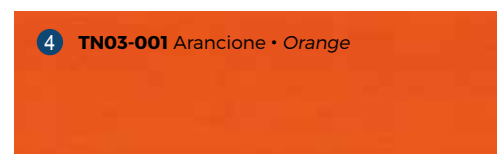
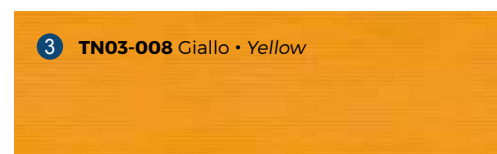
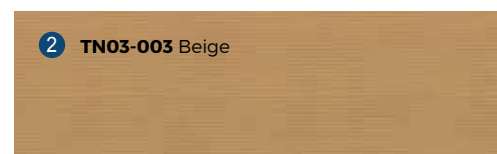

MEHLER AIRTEX® CLASSIC

- Altezza rotolo: 170 cm
- Composizione: 100% poliestere
- Spalmatura: resina acrilica su un lato
- Peso: 200 g/m²
- Solidità del colore alla luce (DIN EN ISO 105 B02): 6-8
- Solidità del colore alle intemperie (DIN EN ISO 105 B04): 6-8
- Spray test - ISO 4920: >3
- Fattore di protezione solare: UPF 80

- Height roll: 170 cm
- Composition: 100% polyester
- Coating: acrylic resin on one side
- Weight: 200 g/m²
- Colour light fastness (DIN EN ISO 105 B02): 6-8
- Colour fastness wheater condition (DIN EN ISO 105 B04): 6-8
- Spray test - ISO 4920: >3
- Solar protection factor: UPF 80



Codice • Code	Colore • Colour
TN03-004	1 Bianco • White
TN03-003	2 Beige
TN03-008	3 Giallo • Yellow
TN03-001	4 Arancione • Orange
TN03-013	5 Rosso • Red
TN03-007	6 Bordeaux
TN03-014	7 Verde • Green
TN03-006	8 Blu Cielo • Blue Sky
TN03-011	9 Laguna • Lagoon
TN03-005	10 Blu • Blue
TN03-002	11 Argento • Silver
TN03-009	12 Grigio • Grey
TN03-010	13 Grigio scuro • Dark Grey
TN03-012	14 Nero • Black

PVC

POLYMAR® NAUTICA BOAT LINE

- Altezza rotolo: 220 cm
- Tessuto di supporto: 100% PES
- Spalmatura: Monospalmato in PVC
- Peso: 450g/m²
- Finissaggio: Trattamento fungicida, Goffrato
- Solidità colore alla luce (DIN EN ISO 105 B02): 7-8
- Solidità colore alle intemperie (DIN EN ISO 105 B04): 7-8

- Height Roll : 220 cm
- Base fabric: 100% PES
- Coating: PVC on one side
- Weight: 450g/m²
- Finish: fungicide, leather embossing
- Colour light fastness (DIN EN ISO 105 B02): 7-8
- Colour fastness wheater condition (DIN EN ISO 105 B04): 7-8



Codice • Code	Colore • Colour
TN04-002	1 Bianco • White
TN04-003	2 Grigio • Grey
TN04-004	3 Beige



VALMEX® NAUTICA LEICHT

- Altezza rotolo: 220 cm
- Tessuto di supporto: 100% PES
- Lato esterno: PVC/MEHATOP
- Lato interno: PES
- Peso: 280g/m²

- Height Roll : 220 cm
- Base fabric: 100% PES
- Front side: PVC/MEHATOP
- Back side: PES
- Weight: 280g/m²



Codice • Code	Colore • Colour
TN04-007	4 Blu • Blue
TN04-006	5 Bianco • White
TN04-008	6 Grigio • Grey
TN04-005	7 Beige

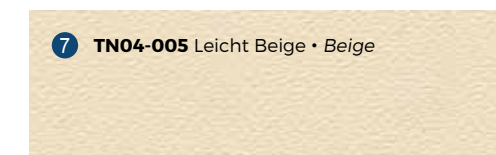

ECOPELLE • SYNTHETIC LEATHER

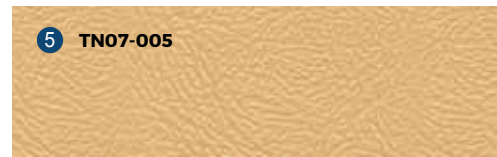

BISON

- Altezza rotolo: 138 cm | 140 cm
- Composizione: 85% PVC | 15% PE
- Peso: 700 gr/m² ± 5% (UNI 4818)
- Spessore: 1,15 mm ± 5% (UNI 4818)
- Disponibile in altri colori

- Height Roll: 138 cm | 140 cm
- Composition: 85% PVC | 15% PE
- Weight: 700 gr/m² ± 5% (UNI 4818)
- Thickness: 1,15 mm ± 5% (UNI 4818)
- Other colours available

Codice • Code	Colore • Colour
TN07-001	1 Avorio • Ivory
TN07-002	2 Bianco • White
TN07-003	3 Biscotto • Biscuit
TN07-004	4 Blu • Blue
TN07-005	5 Crema • Cream
TN07-006	6 Grigio Chiaro • Light Grey



CRYSTAL

Crystal trasparente, impermeabile e resistente ai raggi UV, adatto per la realizzazione di finestrate per capottine, sprayhood e gazebo.
Disponibile in due spessori: il 5/10 è consigliato per piccole finestrate, mentre lo spessore 8/10 (0,8mm) per ampie finestrate.

- Composizione: PVC trasparente
- Altezza rotolo: 137 cm

Transparent Crystal, waterproof and UV rays resistant, suitable for windows, hoods and gazebos.
Available in two thicknesses, 5/10 suitable for small windows, whereas 8/10 (0,8mm) for wide ones.

- Composition: Transparent PVC
- Roll height: 137 cm

Codice • Code	Spessore mm • Thickness (inch)
TN05-001-A	0,5 (0,02")
TN05-001-B	0,8 (0,03")



RETE OMBREGGIANTE • SHADING MESH

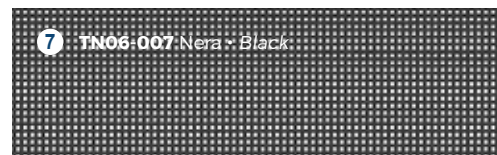

SERGE FERRARI

- Altezza rotolo: 180 cm
- Composizione: filo di poliestere HT rivestito di PVC
- Peso: 500 gr/m²
- Resistente ai raggi UV

- Height Roll: 180 cm
- Composition: PVC coated HT polyester thread
- Weight: 500 gr/m²
- UV resistant

Serge Ferrari

Codice • Code	Colore • Colour
TN06-003	1 Bianco • White
TN06-002	2 Beige • Beige
TN06-008	3 Nocciola • Hazelnut
TN06-004	4 Blu • Blue
TN06-005	5 Grigio • Grey
TN06-006	6 Grigio Antracite • Anthracite Grey
TN06-007	7 Nero • Black



RETE MICROFORATA OMBREGGIANTE BIANCA WHITE MICRO PERFORATED SHADING MESH

RETE PVC PER SOTTOCUSCINI BARCHE

- Altezza rotolo: 160 cm
- Peso: 300g/m²
- Spalmatura: PVC
- Titolo del filato: Dtex 1100
- Colore: Bianco

PVC MESH FOR BOAT UNDERCUSHIONS

- Height Roll: 160 cm
- Weight: 300g/m²
- Coating: PVC
- Count: 1Dtex 1100
- Color: White

Codice • Code	Colore • Colour
TN06-001	Bianco • White

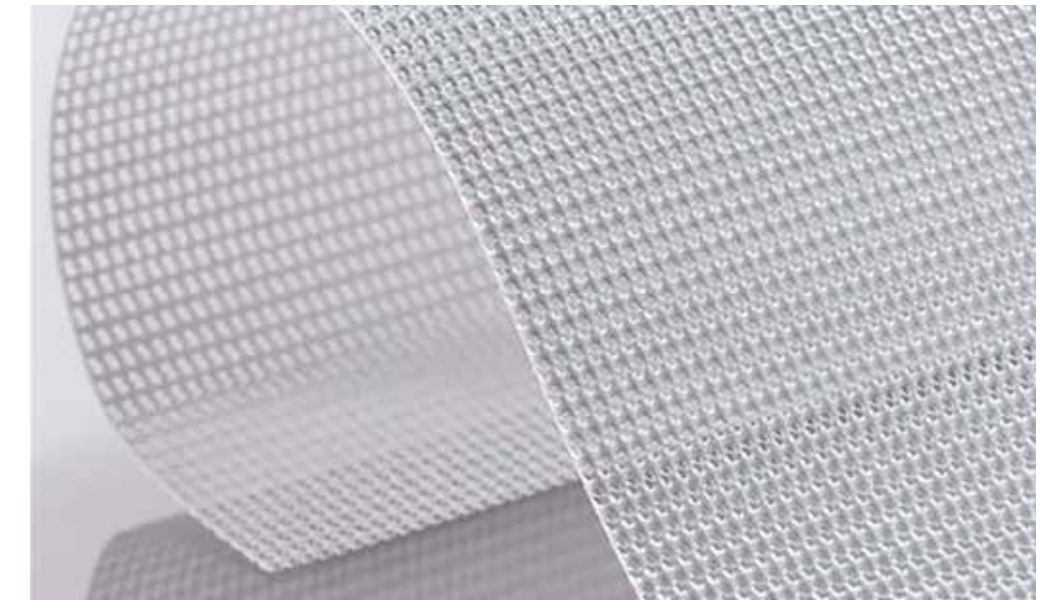

TESSUTO POLIESTERE STABILIZZATO DACRON PER VELE DACRON POLYESTER FABRIC FOR SAILS

Tessuto poliestere stabilizzato DACRON non adesivo adatto alla realizzazione di vele.

- Altezza rotolo: 140 cm
- Peso: 364 g/m²
- Colore: Bianco

DACRON Polyester fabric non-adhesive suitable for of sails manufacturing.

- Height Roll : 140 cm
- Weight: 364 g/m²
- Color: White



Codice • Code
TN08-001



DETERGENTI ED IMPERMEABILIZZANTI CLEANING AND WATERPROOFING PRODUCTS



Detergente per rete Serge Ferrari
Cleaner for Serge Ferrari mesh

Codice • Code	L
IM003	0,5



Detergente TEX'AKTIV CLEAN per tessuti da esterno
TEX'AKTIV CLEAN fabric cleaner

Codice • Code	L
IM004	1



Detergente spray per finestre in plastica e panno in microfibra
Spray cleaner for plastic windows + microfiber cloth

Codice • Code	L
IM005	0,4



Impermeabilizzante TEX'AKTIV GUARD per tessuti
TEX'AKTIV GUARD fabric waterproofing

Codice • Code	L
IM006	1

ACCESSORI TAPPEZZERIA



Accessori di prima qualità come filato, cerniere, ganci e fibbie sono elementi fondamentali per la realizzazione di un buon prodotto. Nettuno Marine Equipment sceglie con cura e attenzione i migliori accessori utili a **rifinire e personalizzare** ogni manufatto di tappezzeria nautica.

*First quality accessories such as yarn, zippers, hooks and buckles are fundamental elements for the manufacturing of a good product. Nettuno Marine Equipment chooses with care and attention the best accessories to **refine and customize** each upholstery nautical product.*

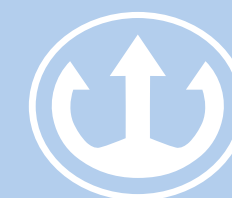

UPHOLSTERY ACCESSORIES

BORDO, FILATO E VELCRO TAPE, THREAD, VELCRO

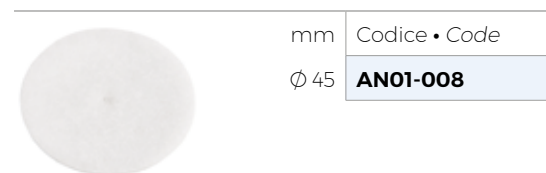

mm	Codice • Code
Ø 45	AN01-008

Velcro a disco femmina
Ø45mm
Female Velcro disc
Ø45mm

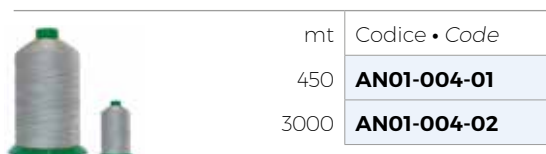

mt	Codice • Code
450	AN01-004-01
3000	AN01-004-02

Spola di filo in poliestere titolo 30
Bianco, beige, bordeaux, grigio chiaro, grigio scuro, verde, blu chiaro, blu scuro, nero **450mt o 3000mt**
Polyester yarn count 30
White, beige, bordeaux, light grey, dark grey, green, light blue, dark blue, black **450mt or 3000mt**



mm	Codice • Code
23	AN01-001

Bordo in acrilico
disponibile in tutti i colori acrilico
Acrylic tape
available in all acrylic colors

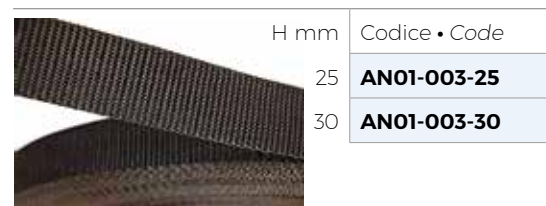

H mm	Codice • Code
25	AN01-003-25
30	AN01-003-30

Nastro in polipropilene
disponibile in bianco, blu, nero, grigio, beige
Tape in polypropylene
available in white, blue, black, gray, beige

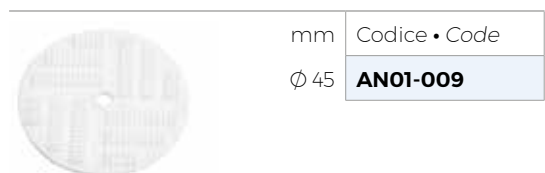

mm	Codice • Code
Ø 45	AN01-009

Velcro a disco maschio
Ø45mm
Male Velcro disc
Ø45mm

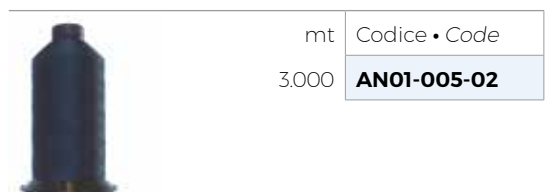

mt	Codice • Code
3.000	AN01-005-02

Spola di filo in poliestere titolo 40
Bianco, beige, blu, nero
Polyester yarn count 40
White, beige, blue, black



Codice • Code
AN01-007

Nastro biadesivo acrilico con supporto in poliestere
Rotolo da 0,6mm x 50 metri
Double sided acrylic tape with support in polyester
0.6mm x 50m roll



Colore • Colour	Cod. • Code
H 20mm ○	AN01-010
H 20mm ●	AN01-011
H 20mm ●	AN01-012
H 20mm ●	AN01-013
H 20mm ●	AN01-014
H 30mm ●	AN01-015
H 30mm ○	AN01-016
H 30mm ●	AN01-017
H 30mm ●	AN01-018
H 30mm ●	AN01-019
H 50mm ●	AN01-020
H 50mm ○	AN01-021
H 50mm ●	AN01-022
H 50mm ●	AN01-023
H 50mm ●	AN01-024

Velcro maschio + femmina
Confezione da 5mt
Velcro male + female
Pack of 5 meters



mm	Codice • Code
25	AN01-002

Bordo in poliestere
disponibile in tutti i colori poliestere
Polyester tape
available in all polyester colors

CORDA ELASTICA E GANCI ELASTIC ROPE AND HOOKS



mm	Codice • Code
Ø 3	AN02-013-3
Ø 4	AN02-013-4
Ø 5	AN02-013-5
Ø 6	AN02-013-6
Ø 8	AN02-013-8

Corda elastica
in lattice e poliestere da Ø 3 a Ø 8
Elastic rope
latex rubber and polyester from Ø 3 to Ø 8



Colore • Colour	Codice • Code
○	AN02-007
●	AN02-008

Confezione di 20 gancetti terminali
in nylon per corda Ø 6mm
Pack of 20 nylon small hooks
for Ø 6mm elastic rope



Colore • Colour	Codice • Code
○	AN02-003

Confezione di 10 moschettoni
in nylon bianco per corda elastica Ø8mm
Pack of 10 white nylon snap-hooks
for Ø8mm elastic rope

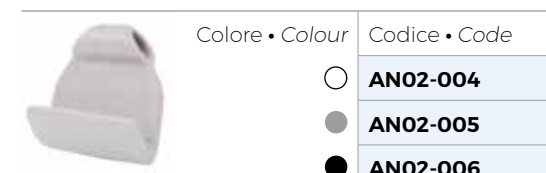

Colore • Colour	Codice • Code
○	AN02-004
●	AN02-005
●	AN02-006

Confezione di 20 gancetti chiusi
in nylon per corda Ø 6-8mm
Pack of 20 nylon small closed hooks
for Ø 6-8mm elastic rope



Colore • Colour	Codice • Code
○	AN02-012

Confezione di 20 gancetti semichiusi
in nylon bianco
Pack of 20 half closed hooks
white nylon

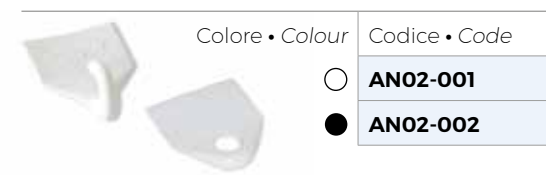

Colore • Colour	Codice • Code
○	AN02-001
●	AN02-002

Confezione di 10 ganci e 10 occhielli in nylon
per tendalini e coperture
Pack of 10 nylon hooks and 10 eyelets
for Bimini Tops and covers

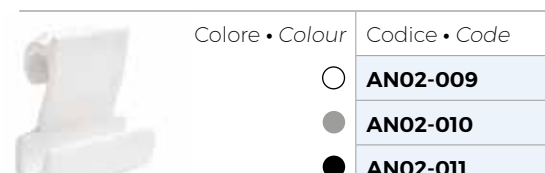

Colore • Colour	Codice • Code
○	AN02-009
●	AN02-010
●	AN02-011

Confezione di 20 gancetti
in nylon per corda Ø 6-8mm
Pack of 20 nylon small hooks
for Ø 6-8mm elastic rope

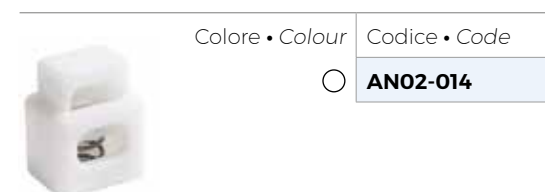

Colore • Colour	Codice • Code
○	AN02-014

Fermacorda quadro in nylon bianco
con molla in acciaio inox
White nylon square rope stopper
with stainless steel spring

BOTTONI, FUNGHETTI E TORNICHETTI

SNAP FASTNERS, BUTTONS, TURN BUTTONS



Colore • Colour	Codice • Code
○	AN03-011
●	AN03-012



Colore • Colour	Codice • Code
○	AN03-008
●	AN03-009



Codice • Code
AN03-010



Codice • Code
AN03-016



Codice • Code
AN03-013

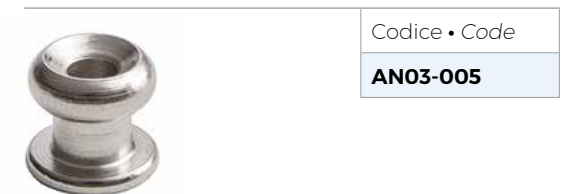

Codice • Code
AN03-005

Testa bottone PERFIX®
con bottone PERFIX® per fissaggio su tessuto
PERFIX® head
with PERFIX® button for fixing on fabrics



Codice • Code
AN03-019

Bottone femmina PERFIX®
con vite inox per fissaggio su coperta
Female PERFIX® snap fastener
with stainless steel screw. Mounting on deck



Codice • Code
AN03-018

Chiavetta per bottoni PERFIX®
PERFIX® snap-fasteners key



Codice • Code
AN03-001

LOXX® maschio su piastra
a 2 fori in ottone cromato
Nickel-plated brass male LOXX®
snap fastener with 2 holes

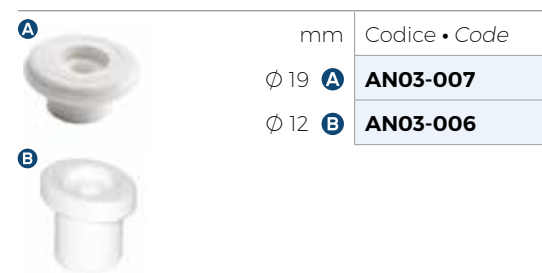

mm	Codice • Code
Ø 19 A	AN03-007
Ø 12 B	AN03-006

LOXX® chiavetta
LOXX® key



Codice • Code
AN03-002

Funghetto in acciaio inox AISI 316
Ø3,9 mm
Stainless steel Norwegian knob
Ø3,9 mm



Codice • Code
VL 40 AN03-003
VL 60 AN03-004

Tornichetto collo basso in acciaio inox
Stainless steel Turn button - Low



Codice • Code
AN03-017

Tornichetto collo alto in acciaio inox
Stainless steel Turn button - High



Codice • Code
AN03-014

Asola + Piattino inox per tornichetti
Grommet + steel back plate for turn buttons



Codice • Code
AN03-015

A Funghetto tondo Nylon bianco Ø 19mm
Round button White nylon Ø 19mm

B Funghetto ovale Nylon bianco Ø 12mm
Oval button White nylon Ø 12mm



Colore • Colour	Codice • Code
○	AN03-020
●	AN03-021

Confezione di 20 bottoni
con sottobottoni automatici in acciaio inox AISI 316
Pack of 20 pcs
of AISI 316 stainless steel snap fasteners

Confezione di 20 occhielli acciaio inox
VL 40: 10 mm interno x 18 mm esterno
VL 60: 16 mm interno x 24 mm esterno
Set of 20 stainless steel eyelets
VL 40: 10 mm internal x 18 mm external
VL 60: 16 mm external x 24 mm external

Testa bottone LOXX®
con molla interna inox
LOXX® snap fastener head
with stainless steel spring

LOXX® maschio autofilettante
Male LOXX® self tapping snap fastener

LOXX® maschio
per fissaggio su tessuto in ottone nichelato
Nickel-plated brass male LOXX®
snap fastener for fabrics fixing

Gancio con corda elastica + funghetto
Hook with elastic cord + button

FIBBIE E PONTICELLI BUCKLES AND LACING EYES

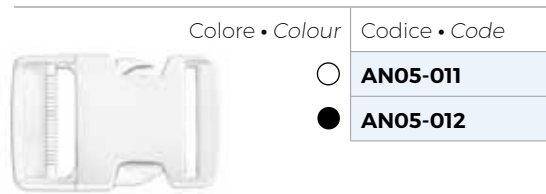

Fibbia a scatto rapido
in resina acetilica per nastro da 25mm
Snap buckle
acetal resin for 25mm tape

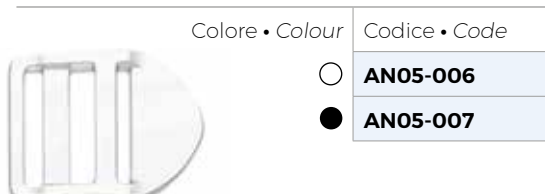

Fibbia a tre vie in nylon
Passaggio 25mm
Three ways nylon buckle
Passage 25mm

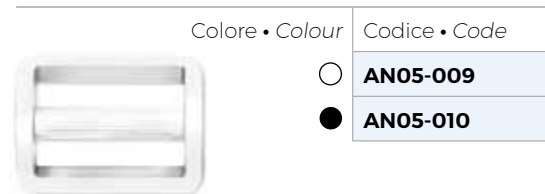

Fibbia passante a due luci
in nylon per nastro da 25mm
Nylon two-lights regulating loop buckle
for 25m straps

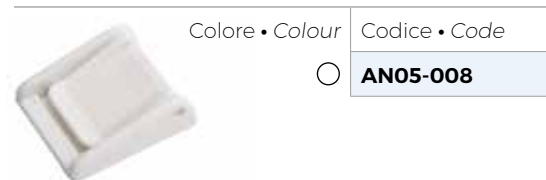

Fibbia in nylon bianca
da fissare alla barca. Passaggio 30mm
White nylon buckle
to be fixed on the boat. Passage 30mm

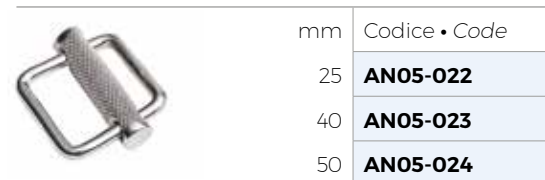

Tendi nastro con freno
acciaio inox AISI 304. Passaggio 25/40/50mm
Strap latch with snap-hook
AISI 304 Stainless steel. Passage 25/40/50mm



Tendi nastro con freno e moschettone
in acciaio inox AISI 316. Passaggio 25mm
Strap latch with snap-hook and brake
AISI 316 Stainless steel. Passage 25mm



Fibbia a doppia luce
in acciaio inox AISI 304. Passaggio 25 mm
Double way strap latch
AISI 304 Stainless steel. Passage 25mm

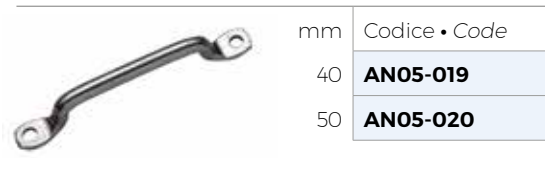

Ponticello passacinghie piatto
in acciaio inox AISI 316. Passaggio 40/50mm
Flat stainless steel jumper
AISI 316 Stainless steel. Passage 40/50mm



Ponticello in acciaio inox
AISI 304. Passaggio 17/18,5mm
Stainless steel jumper
AISI 304 Stainless steel. Passage 17/18,5mm



Ponticello passacinghie
in acciaio inox AISI 316. Passaggio 30mm
Flat eye strap
AISI 316 Stainless steel. Passage 30mm



Ponticello base rettangolare
∅6mm. In acciaio inox AISI 304. Misure: 40x35mm
Diametro passaggio: ∅ 18mm
AISI 304 Stainless steel rectangular pad eye
arch ∅6mm. Measure: 40x35mm. Passage: ∅ 18mm



Ponticello passacinghie
in nylon bianco. Passaggio 30mm
White nylon eye strap
Passage 30mm



Piastrina tendicorda
in acciaio inox AISI 316
Bimini Top rope tensioner plate
AISI 316 stainless steel

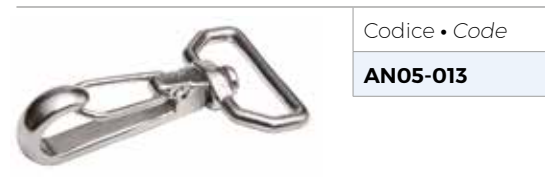

Moschettone occhio piatto
in acciaio inox AISI 316
Flat snap-hook
AISI 316 stainless steel



Anello triangolo
in acciaio inox lucidato AISI 316. Passaggio 30mm
Triangle ring
AISI 316 Polished stainless steel. Passage 30mm

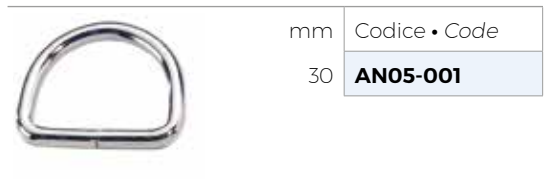

Anello a D
in acciaio inox AISI 316. Passaggio 30mm
D ring
AISI 316 Polished stainless steel. Passage 30mm



Anello rettangolare
in acciaio inox AISI 316. Passaggio 25mm
Rectangular ring
AISI 316 Polished stainless steel. Passage 25mm



Anello in silicone
Dimensioni: ∅ 4.2cm x 0.50cm
Silicon ring
Dimensions: ∅ 4.2cm x 0.50cm

GOMMA CELLULA CHIUSA CLOSED CELL RUBBER









Gomma a cellula chiusa
Closed cell rubber

mm	Codice • Code
1000 x 2000 x 20	AN06-001-20
1000 x 2000 x 30	AN06-001-30
1000 x 2000 x 40	AN06-001-40
1000 x 2000 x 50	AN06-001-50

CERNIERE LAMPO YKK YKK ZIPPERS



Colore • Colour	Codice • Code
	○ AN04-008
	● AN04-009
	● AN04-011
	● AN04-007
	● AN04-010

Colore • Colour	Codice • Code
	○ AN04-003
	● AN04-004
	● AN04-006
	● AN04-002
	● AN04-005

Colore • Colour	Codice • Code
	○ AN04-001





Cerniera lampo pressofusa YKK catena divisibile 8mm
con cursore reversibile metallo.
Lunghezze disponibili da 50cm a 500cm
Divisible die-cast YKK zipper chain 8mm
with reversible metal slider
Lengths available from 50cm to 500cm

Cerniera lampo pressofusa YKK catena divisibile 10mm
con cursore doppia aletta in plastica
Lunghezze disponibili da 50cm a 500cm
Divisible die-cast YKK zipper chain 10mm
with double plastic slider
Lengths available from 50cm to 500cm

Cerniera lampo a spirale YKK catena divisibile 10mm
con doppia aletta in metallo.
Lunghezze disponibili da 400cm a 700cm
Divisible spiral YKK zipper chain 10mm
with double metal slider
Lengths available from 400cm to 700cm

Colore • Colour	Codice • Code
	○ AN04-017

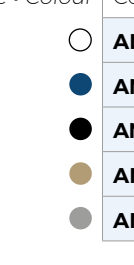
Colore • Colour	Codice • Code
	○ AN04-013
	● AN04-014
	● AN04-016
	● AN04-012
	● AN04-015

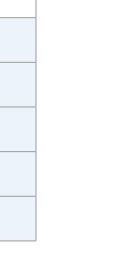
Colore • Colour	Codice • Code
	○ AN04-019
	● AN04-020
	● AN04-022
	● AN04-018
	● AN04-021

Cerniera lampo a spirale YKK catena continua 5mm
Continuous spiral YKK zipper chain 5mm

Cerniera lampo pressofusa YKK catena continua 8mm
Continuous die-cast YKK zipper chain 8mm

Cursore in metallo
per cerniera lampo pressofusa YKK catena continua 8mm
Metal slider
for continuous die-cast YKK zipper chain 8mm

Colore • Colour	Codice • Code
	○ AN04-023

Cursore in plastica
per cerniera lampo a spirale YKK catena continua 5mm
Plastic slider
for continuous spiral YKK zipper chain 5mm

BINARI, PRESE D'ARIA, SUPPORTI TELONI RAILS, VENTS AND COVERS SUPPORTS



mm	Codice • Code
Ø 20	AN07-001



Appoggio per telo copribarca
Dimensioni foro: Ø 20mm
Boat cover canvas support base
Hole dimensions: Ø 20mm

mm	Codice • Code
Ø 10	AN07-002



Binario in PVC bianco
Ø 10mm senza aletta
White PVC rail
Ø 10mm without aisle

cm	Codice • Code
75/120	AN07-004-A
90/160	AN07-004-B

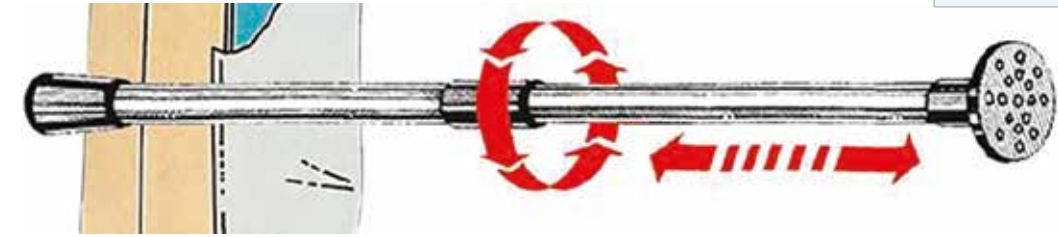

Supporto telescopico per telone barca
in lega leggera anodizzata e appoggio in PVC morbido.
Ø tubo: 25/30mm

mm	Codice • Code
Ø 7	AN07-005-7
Ø 8	AN07-005-8



Tubetto in PVC bianco
per binario con doppia aletta
White PVC rail profile
with double slider

mm	Codice • Code
Ø 7.8	AN07-006



Tubetto in PVC nero
per binario con doppia aletta
Black PVC rail profile
with double slider

Boat telescopic cover support
made of anodized light alloy and soft PVC support.
Ø tube: 25/30mm

Codice • Code
AN07-003



Presad'aria
per coperture e chiusure totali nautiche
Vent
for boat covers and full enclosures

Codice • Code
AN07-007



Binario in PVC nero
barra da 2,3mt
Black PVC rail
Bars of 2,3m

CAVI E TERMINALI WIRE ROPES AND TERMINALS



mm	Codice • Code
Ø 3	AN08-002

Cavo draglie in acciaio inox
Ø 3mm 1x19
Stainless steel lifelines cable
Ø 3mm 1x19



mm	Codice • Code
Ø 6	AN08-001

Cavo draglie in acciaio inox con rivestimento in PVC
Flessibile 7x7 (49 fili) Ø 4 mm - Ø esterno con PVC mm 6
Stainless steel lifelines cable covered with PVC
Flexible 7x7 (49 wires) Ø 4 mm - External Ø with PVC mm 6



Codice • Code
AN08-004

Moschettone a pellicano con filettatura interna in acciaio inox
inox AISI 316 con filettatura interna M6
Stainless steel pelican hook with internal thread
AISI 316 stainless steel with M6 internal thread



mm	Codice • Code
Ø 3	AN08-010

Terminale filettato M6 in acciaio inox
AISI 316 per cavo Ø3mm
M6 threaded stainless steel terminal
AISI 316 for Ø3mm cable



mm	Codice • Code
Ø 3	AN08-005
Ø 4	AN08-006

Tenditore terminale a forcella per cavo Ø 3 | 4 mm
in acciaio inox AISI 316. Filettatura interna M6
Turnbuckle fork-terminal for wire cable Ø 3 | 4mm
AISI 316 stainless steel. M6 Internal thread

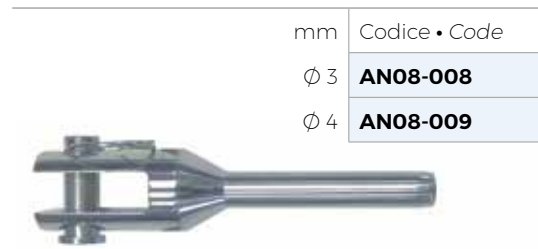

mm	Codice • Code
Ø 3	AN08-008
Ø 4	AN08-009

Terminale a forcella per cavo Ø 3 | 4 mm
in acciaio inox AISI 316
Fork terminal for wire rope Ø 3/4mm
Stainless steel AISI 316



mm	Codice • Code
Ø 4	AN08-007

Terminale a forcella ad attacco rapido per cavo Ø 4mm con serraggio manuale in acciaio inox AISI 316
Quick connection fork terminal for Ø 4mm wire cable with manual tightening in AISI 316 stainless steel



MT	Codice • Code
6	AN08-003-A
8	AN08-003-B
10	AN08-003-C
12	AN08-003-D
15	AN08-003-E

Kit ricambio draglie
Spare Lifelines Kit

ACCESSORI TAPPEZZERIA • UPHOLSTERY ACCESSORIES

SCORRITENDA E ACCESSORI RAILS FOR BLINDS AND ACCESSORIES



Colore • Colour	Codice • Code
○	AN09-001-12/BIA
●	AN09-001-12/ARG

Binario in alluminio per tende leggere
Profilo preforato con passo di 120 mm
Colori: bianco, argento.
Aluminum rail for light interior curtains
Perforated profile with 120 mm pitch
Colors: white, silver.



Codice • Code
AN09-007

Confezione 20 scorrevoli bianchi per binario
Pack of 20 white sliding parts for rail



mm	Codice • Code
25	AN09-002-25/BIA
40	AN09-002-40/BIA
65	AN09-002-65/BIA

Nastro arricciatende bianco
White curtain ribbon



Codice • Code
AN09-003

Confezione 2 fermi bianchi per binario
Pack of 2 pieces white rail stoppers



Codice • Code
AN09-006

Confezione 20 ganci bianchi a proboscide per binario
Pack of 20 white hooks for blind rail



Colore • Colour	Codice • Code
○	AN09-004
●	AN09-005

Confezione 2 tappi terminali per binario
Pack of 2 terminal pieces for rail



Codice • Code
AN09-008

Confezione 5 supporti bianchi a soffitto per binario
Pack of 5 white ceiling mounts for track

FILOSOFIA AZIENDA

Qualità. Artigianalità. Innovazione.

Ogni prodotto che realizziamo è progettato e costruito con i migliori materiali e la massima attenzione ai dettagli per garantire comfort, stile e resistenza nel tempo.

L'arte della manualità ci permette di creare prodotti unici, capaci di "vestire" le imbarcazioni come un abito sartoriale.

La tecnologia ci aiuta ad offrire soluzioni innovative e prodotti sempre nuovi e all'avanguardia.

Quality. Craftsmanship. Innovation.

Every product we make is designed and manufactured with the best materials and the utmost attention to detail to ensure comfort, style and durability over time.

The art of craftsmanship allows us to create unique products, able to "dress" boats, just like a tailored dress.

Technology help us to offer innovative solutions and new cutting-edge products.

BUSINESS PHILOSOPHY

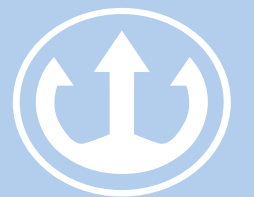

Una storia di passione e competenza

Ⓜ Nettuno Marine Equipment Srl è un'impresa italiana artigianale e a conduzione familiare.

Il progetto nasce nel 2008, quando le competenze tecniche e gestionali di Raffaele Garofalo si uniscono all'esperienza sartoriale di suo padre Gennaro per dare vita ad una prima, ristretta, linea di articoli a marchio Nettuno Marine Equipment® dedicati alla nautica.

Oggi l'azienda propone un'offerta completa - dalla realizzazione di prodotti standard alla progettazione di soluzioni su misura - e un supporto commerciale e tecnico qualificato e professionale, riuscendo a soddisfare le esigenze di qualunque armatore e allestendo ogni tipologia di imbarcazione in tutto il mondo.

A story of passion and competence

Ⓜ Nettuno Marine Equipment Srl is an artisanal, family-run Italian company.

The project was born in 2008, when Raffaele Garofalo's technical and managerial skills joined his father Gennaro's tailoring experience to give life to a first, limited line of Nettuno Marine Equipment® branded items dedicated to the boating industry.

Today, the company proposes a complete offer - from the production of standard products to the design of made-to-measure solutions - and qualified and professional commercial and technical support, succeeding in meeting the needs of any shipowner and outfitting any type of boat anywhere in the world.



www.nettunome.it • info@nettunome.it



NETTUNO[®]
Marine Equipment

ITALIAN QUALITY BOAT COVERS

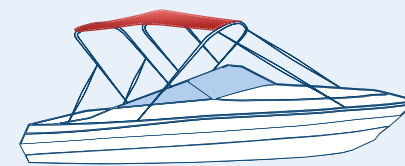

Nettuno Marine Equipment srl

Via Pantanelli 34-36 • 61025 Montelabbate (PU) ITALY

P.IVA 02733410415 • COD. SDI G4A1IU8

Tel: +39 0721 499984 • Fax: +39 0721 1850049